

MATHEMATICS
Grade 3
TERM 2 2019
Lesson
Plans

Acknowledgement:

These lesson plans have been developed based on previous sets of lesson plans (GPLMS and PILO) which have been adapted to align with the Mathematics Framework for South Africa: Teaching Mathematics for Understanding.

Contents

Teaching mathematics for Understanding (TMU)	1
Glossary of important terms used in the TMU lesson plans	2
About the Lesson Plans and Resources	8
Preparing to teach a lesson	10
Lesson Plan Outline	12
Week 1	15
Unit 1 Introduction	15
Lesson 1: Multiplication tables up to 5	16
Lesson 2: Multiplication using array diagrams	19
Lesson 3: The 6 times table	23
Lesson 4: The 6 times table	27
Lesson 5: Consolidation	31
Week 2	34
Lesson 6: The 7 times table	34
Lesson 7: The 7 times table	38
Lesson 8: Assessment	42
Lesson 9: The 8 times table	44
Lesson 10: Consolidation	48
Week 3	50
Lesson 11: The 9 times table	50
Lesson 12: The 8 and 9 times tables	54
Lesson 13: The 1 times table	59
Lesson 14: Doubling and repeated addition	63
Lesson 15: Consolidation	67
Week 4	70
Lesson 16: Assessment	70
Unit 2 Introduction	72
Lesson 17: Multiplication patterns	73
Lesson 18: Patterns in multiplication tables	78
Lesson 19: Multiply by 10	82
Lesson 20: Consolidation	85

Week 5	87
Lesson 21: Assessment	87
Lesson 22: Multiply by 0 and find the missing number	89
Lesson 23: More multiplication patterns	92
Lesson 24: Assessment	95
Lesson 25: Consolidation	97
Week 6	100
Unit 3 Introduction	100
Lesson 26: Time	101
Lesson 27: Measuring Time	105
Lesson 28: Time passed	109
Lesson 29: Calendars	112
Lesson 30: Consolidation	115
Week 7	117
Lesson 31: Assessment	117
Unit 4 Introduction	119
Lesson 32: Circles	120
Lesson 33: Triangles	123
Lesson 34: Squares	126
Lesson 35: Consolidation	128
Week 8	130
Lesson 36: Rectangles	130
Lesson 37: Assessment	133
Lesson 38: Sort and Compare 2-D shapes	135
Lesson 39: Consolidation of 2-D shapes	138
Lesson 40: Consolidation	141
Week 9	143
Lesson 41: Symmetry Part 1	143
Lesson 42: Symmetry Part 2	147
Lesson 43: Assessment	151
Lesson 44: Geometric patterns	153
Lesson 45: Consolidation	156
Week 10	158
Lesson 46: Geometric patterns around us	158
Lesson 47: Creating geometric patterns	161
Lesson 48: Exploring geometric patterns	164
Lesson 49: Assessment	167
Lesson 50: Consolidation	169

Teaching mathematics for Understanding (TMU)

You are participating in the pilot implementation of the Mathematics Framework – which calls for *Teaching Mathematics for Understanding*. Diagrammatically the framework is represented as shown below.

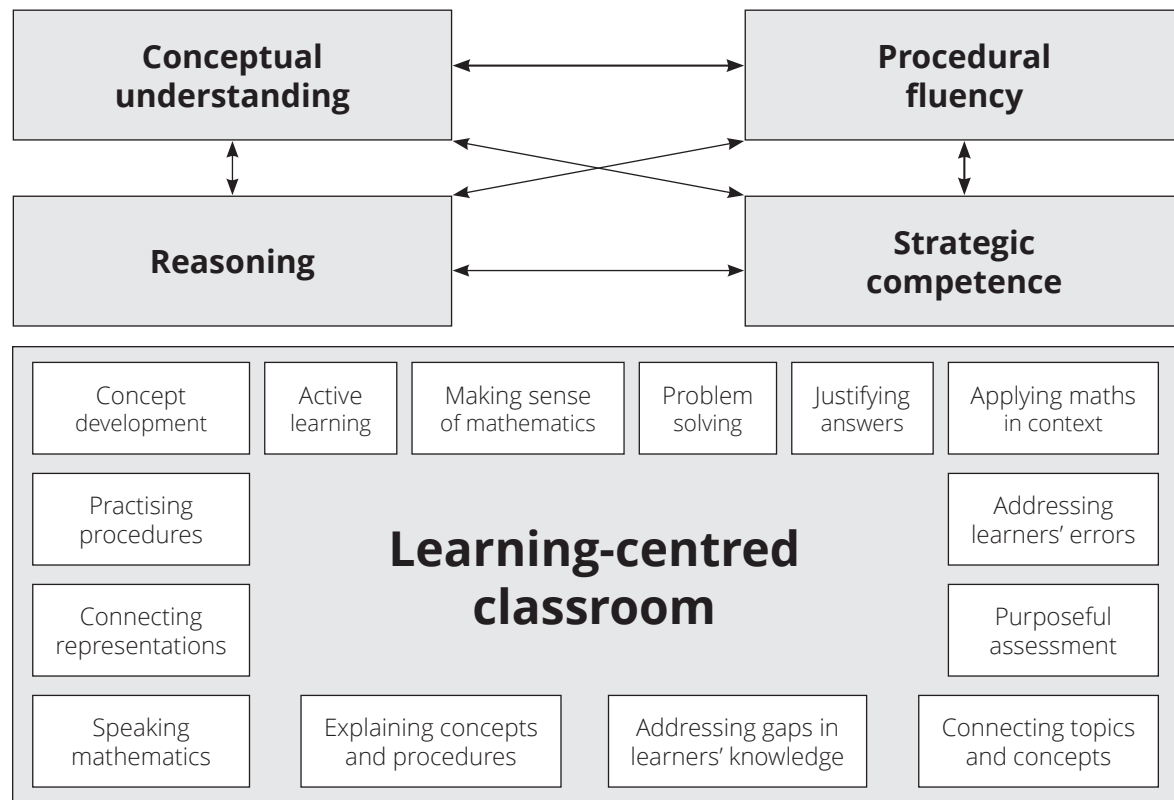

The Framework proposes that steps should be taken to bring about the transformation of mathematics teaching in South Africa. Teachers should strive to:

- teach mathematics for **conceptual understanding** to enable comprehension of mathematical concepts, operations, and relations;
- teach so that learners develop **procedural fluency** which involves skill in carrying out procedures flexibly, accurately, efficiently, and appropriately;
- develop learners' **strategic competence** – the ability to formulate, represent, and decide on appropriate strategies to solve mathematical problems;
- provide multiple and varied opportunities for learners to develop their mathematical **reasoning** skills – the capacity for logical thought, reflection, explanation and justification; and
- promote a **learning-centred classroom** which teachers support by engaging with learners in ways that foreground mathematical learning, thus enabling all of the above.

The lesson plans you will follow are designed to help you teach according to the framework dimensions.

Glossary of important terms used in the TMU lesson plans

The following terminologies are used in the TMU lesson plan. Some of them also appear in CAPS.

Calculation

ADDITION WITH CARRYING

The type of addition which occurs when we bridge ten, in single digit (or 2-digit and 3-digit) calculations. For example $9 + 4$, $57 + 26$, $83 + 19$. The term 'carrying' is used since the terminology is familiar to teachers. What happens when we 'carry' is that in order to bridge ten, 10 ones are 'exchanged' to make 1 ten.

SUBTRACTION WITH BORROWING

The type of subtraction which occurs when the units involved in the subtraction create an impasse (a temporary hurdle). For example $14 - 5$, $52 - 27$, $102 - 19$. The units do not allow for subtraction 'on their own'. The term 'borrowing' is used since the terminology is familiar for teachers. What happens when we 'borrow' is that 1 ten is 'exchanged' into 10 ones and grouped with the other ones in the question, to overcome the impasse so that the subtraction can be done.

BASE-TEN NUMBER SYSTEM

The most commonly used number system across the world. Our number system uses a base of ten which means it involves grouping in tens. There are ten units in one ten, ten tens in one hundred and so on. Each digit in a number has a value according to the position it is in. The only digits we need to represent a number of any size are the digits 0 to 9. One focus of the TMU framework is to move from mathematics based on counting methods to methods managed by the base-ten number system.

MAKE-A-TEN METHOD

A calculation technique that learners can use to do addition with carrying and subtraction with borrowing. This method helps learners avoid calculation by counting.

COLUMN METHOD

A calculation technique used in addition and subtraction that helps reinforce number concept or number sense. Also known as the vertical algorithm or vertical method. This structured method consolidates learners' understanding of place value because it is structured using place value. This should help learners to understand the concept of place value and to work meaningfully with numbers (rather than doing tallies and counting).

NUMBER BONDS

A calculation technique that consists of building up (composition) and breaking down (decomposition). For instance, 4 can be broken down into 1 and 3, 2 and 2 and 3 and 1. These are the number bonds of 4. The number bonds of 10 are the most important since they are used in all calculation strategies.

EXPANDED NOTATION

Representation of a number by writing it out using place value. For example 467 is expanded in the following way: $467 = 400 + 60 + 7$. ‘Expanded notation’ and ‘building up and breaking down of numbers’ are used interchangeably in CAPS. In the lesson plans, building up and breaking down are only used as number bonds. Flard card can help learners to acquire knowledge of expanded notation.

SUBITISING

Subitising is ‘an instant cognition of the number of objects’. This is one of the most important skills that learners should acquire in the Foundation Phase. A ten frame is a useful tool to help learners to subitise objects. In the example below, it is easier to recognise the number of dots by putting them in a ten frame.

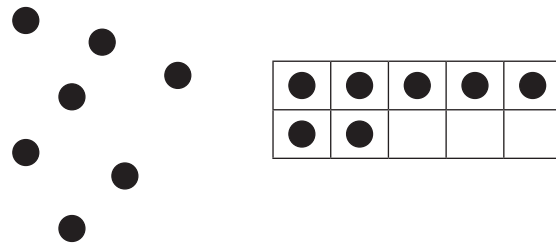

JUMPING STRATEGIES ON A NUMBER LINE

When we solve addition or subtraction with number line, we use ‘jump’ strategies. This strategy builds on learners’ knowledge of numbers and it can also help reinforce number concept or number sense. There are many ways in which ‘jumps’ can be made on number line, but efficient jumps (such as jumping to the next ten or jumping in tens) make the calculations easier. Choosing these ‘efficient jumps’ develops learners’ number sense.



Representations

CPA APPROACH

The Concrete-Pictorial-Abstract (CPA) approach helps learners develop the concepts of numbers. The CPA approach uses several different representations for the concept of numbers 1, 10 and 100.

- **Concrete** objects are any materials that can be touched. In TMU, bottle tops are recommended as concrete objects.
- **Pictorial** representations are drawings that represent concrete objects.
- **Abstract** representations consist of number symbols and symbols such as ‘+’, ‘-’, ‘×’, ‘÷’.

SIMPLIFIED PICTORIALS

A simplified pictorial representation of hundreds, tens and ones are used to write down in paper. The concept of the numbers represented by the pictorials is reinforced when learners draw simplified pictorials. By using simplified pictorials, an enormous time of writing can be saved compared with drawing tallies, circles etc. Simplified pictorials are much more effective than tallies. Tallies should not be drawn beyond ten or a maximum of 20 items.

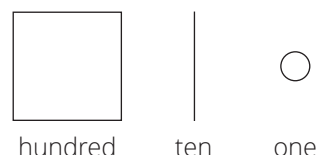

PLACE VALUE TABLE

A diagram showing a number using a display of concrete/semi-concrete objects (bottle tops as units or base ten kit tens and hundreds) and abstract representations (numbers and number names). On the right is the sample of a number 37 shown in the place value table.

Tens	Ones
● ● ●	
● ● ●	
● ● ●	
● ● ●	●
● ● ●	●
● ● ●	●
● ● ●	●
● ● ●	●
● ● ●	●
● ● ●	●
3 tens	7 ones
37	

ARRAY DIAGRAM

The following is the array diagram of 2×4 . The order of multiplication is important and it is consistent with CAPS.



MULTIPLICATION TABLE

Multiplication tables show the multiples of numbers – the answers to the multiplication of several 1×1 digit multiplications, depending on the number of the multiplication table. For example, the 5 times table is $\square \times 5$ and will show all the multiples of 5 by the numbers 1 to 10. Learners must memorise the multiplication tables, because once learners master the multiplication tables, they will be able to divide by applying their knowledge of multiplication.

BAR DIAGRAM

A diagram representing the relationships of numbers in word problems. The following is an example of bar diagram showing addition (combine).

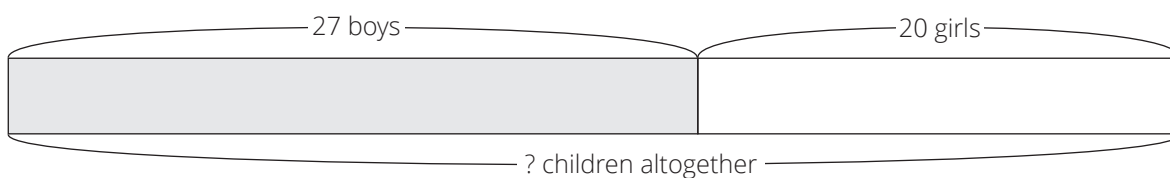

Resources

MANIPULATIVES

These are concrete apparatus such as counters, printed tens, printed hundreds, box and ball shapes, etc. that can be manipulated by learners.

COUNTERS

These are any (loose) concrete objects that learners can manipulate when counting. In the TMU bottle tops are recommended since they are freely available but other counters can also be used such as interlocking cubes (e.g. Unifix cubes). Teachers are expected to use concrete counters such as bottle tops on a big ten frame to help learners develop their number concept as they learn how to count and work with numbers, starting from the number 1. An abacus can be used for counting but since the numbers of the abacus are fixed onto the bars, learners cannot manipulate them as freely. In the lesson plans, all counters are referred to as bottle tops.

DOUBLE-DECKER TEN FRAME (GR1, TERM 1 AND 2)

A ten frame which is made of 2×5 frames. Double-decker ten frames are very helpful when working in the number range 0 to 10. The double-decker ten frame helps learners to understand the numbers 6 to 10 as $5 + 1$, etc. (numbers 1 to 5) by subitising. Learners must put bottle tops onto ten frames themselves when they learn about numbers. The double-decker ten frame give visual clues about the numbers shown on it. This is the number 2 represented on a double-decker ten frame:

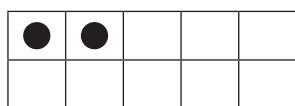

This is the number 7 represented on a double-decker ten frame (visual of 5 plus 2):

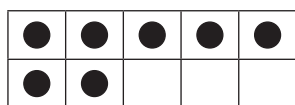

TEN FRAME CARDS (GR 1)

Ten frames with counters already shown in the cards. The example of 5 and 8 are presented. These are also called number picture cards. Learners can start to recognise these cards after working with real ten frames and bottle tops themselves in class.

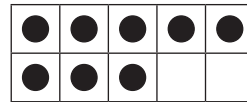
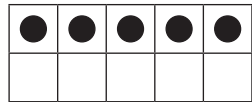

STRAIGHT TEN FRAME (GR 1 TERM 3 AND 4, GR 2, 3)

A ten frame which is straight. The thicker line in the middle shows the 5. This line is important because it helps learners to recognise the numbers 6 to 10 by using the building up skill of 5 and ... (numbers 1 to 5). A straight ten frame is helpful to deal with numbers bigger than 10.



PRINTED TEN

Printed version of a group of 10 ones. You should call them 'ten(s)' in the lesson.



PRINTED HUNDRED (GR 3)

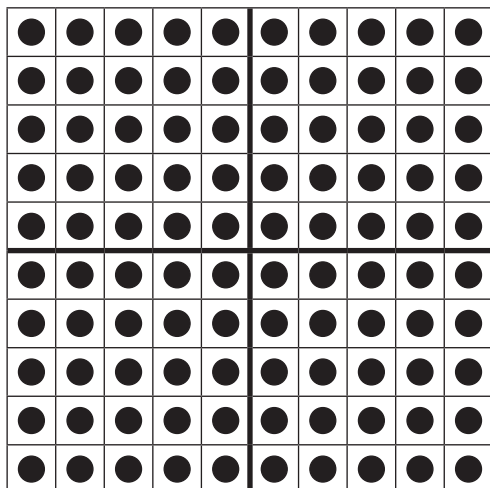

Printed version of a group of 100 ones. You should call them 'hundred(s)' in the lesson.



BASE TEN KITS (ALL)

The concrete number representations used in the TMU lesson plans as 'counters' for ones, tens and hundreds. Bottle tops are used as single counters (to count ones), printed tens are used to count tens and printed hundreds are used to count hundred places. Each learner needs 1 printed hundred, 20 printed tens and 20 or 30 bottle tops. Teachers need 10 big printed hundreds, 20 big printed tens and 20 big bottle tops.

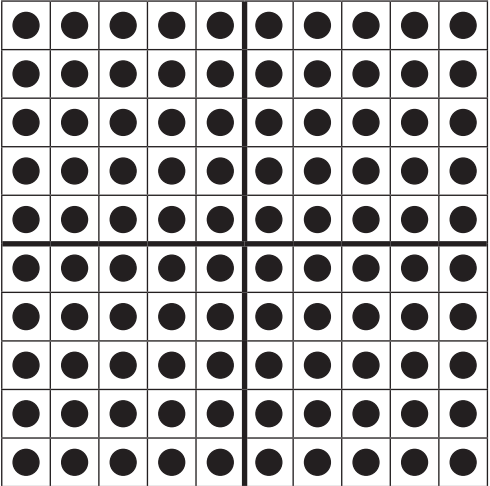
Glossary of important terms used in the TMU lesson plans

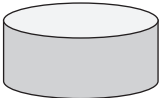
100	10	1
hundred	ten	one
		

About the Lesson Plans and Resources

The lesson plans and resources in this book are part of the Grade 3 Term 2 Teacher Toolkit for the pilot implementation of the mathematics framework.

The other documents in the toolkit are:

- a Lesson and Assessment Planner and Tracker
- a bilingual Learner Mathematics Activity Book
- a set of teacher printable resources
- a bilingual Dictionary of Mathematical Terms

A ABOUT THE LESSON PLANS

The lesson plans give detailed information about how to teach a CAPS-aligned lesson every day. By following the lesson plans, you will ensure that you cover the content and assessment tasks specified in the curriculum and give your learners the best possible chance of developing the knowledge and skills required for Mathematics in this grade.

1 CURRICULUM ALIGNMENT

The lessons are sequenced according to a reorganised CAPS unit planner. The content is CAPS aligned (all topics are covered and the CAPS weighting has been adhered to) but it covers a slightly different sequence to the regular CAPS. Your school has been given permission by the minister to follow this special reorganised curriculum. Lesson plans do show links to the CAPS content and skills being focussed on in the lesson.

2 DBE WORKBOOKS

Pilot implementation schools have been given permission **not** to use the DBE workbooks. You will use your CAPS and lesson plan aligned Learner Activity Books (LAB) instead. The LAB has been designed to include activities from the DBE workbook wherever possible. Bilingual LAB material is provided in English and the LoLT of the school in accordance with the Foundation Phase language policy.

3 BROAD OVERVIEW OF THE CONTENT OF THE LESSON PLANS

Each lesson plan provides a set of steps to guide you in delivering the lesson. In addition, it contains learner activities that will help learners develop the concepts and skills set for the lesson. There are mental maths activities, whole class activities led by the teacher, classwork and homework activities. The answers for the classwork and homework are included in the lesson plans. The classwork and homework activities form the content of the LAB which is provided in a bilingual workbook format.

4 ASSESSMENT

Assessment is provided for in the sequence of lessons. There is also a recommended mark record sheet in the tracker. You can first record your marks in the tracker and then transfer them to SA SAMS.

The programme of assessment suggested in the lesson plans complies with the CAPS as amended by Circular S1 of 2017 and provincial responses to this. Written, oral and practical assessments are provided. Rubrics and checklists with criteria for the oral and practical assessments are also included.

5 MANAGING YOUR TEACHING USING THE LESSON PLAN

A set of orientation activities on eight different topics aligned with the CAPS baseline assessment requirements is provided for the start of the first term. You should use all or a selection of these activities in the first week of term before the formal teaching of the numbered lesson plans begins. The formal curriculum for Term 2 of Grade 3 is covered in a set of 50 numbered lesson plans, paced to cover a 50-day teaching term. This includes 32 fully planned lessons, 8 assessment lessons and 10 consolidation lessons.

Each of the 32 fully planned lessons is designed to last 90 minutes. If your school's timetable has different period lengths, you will have to adjust the amount of work done in each lesson to accommodate this. However, each school should allow seven hours for Mathematics each week so it should be possible to fit in all the work for the week, even if the lengths of periods are not the same as in the lesson plans.

6 SEQUENCE ADHERENCE AND PACING

Each of the fully planned lessons and its contents has been carefully sequenced. You should not skip one of these lessons. Should you miss a school day for any reason, rather skip a consolidation lesson nearby to the lesson that you are busy teaching. You might choose to speed up the pace of delivery to catch up a missed lesson by covering the lesson concept content of two consecutive days in one day. To do this, you could cut out or cut back on some of the routine activities like mental mathematics or homework reflection to save time until you are back on track with the expected delivery of the plans.

Preparing to teach a lesson

The lesson plans provide a detailed lesson design for you to follow. However, to deliver the lessons successfully **you must do the necessary preparation yourself**.

Before you get started, study the contents page of the lesson plan document. This will give you an overview of the mathematics content you will cover during the term.

The information below outlines some key aspects of the preparation required before you teach the lessons.

- a Prepare resources:** The resources needed for each lesson are listed in each lesson plan and in the tracker. It is very important that you check what is required for each lesson ahead of time, so that you have all your resources ready for use every day (e.g. bottle tops, number grids, paper cut-outs, examples of shapes, etc.).
- **Your lessons will not succeed if you have not prepared properly ahead of time.**
 - If you do not have all the necessary resources readily available, see how best you can improvise, e.g. get learners to collect bottle tops or small stones to be used for counting, or make your own flard cards/number grids using pieces of cardboard and a marker pen.
 - Collect empty cool drink cans, cereal boxes, washing powder boxes, plastic bottles etc. for the **shop activity** in the week long in advance, so that you have all the necessary goods to stock your shop.
 - Use newspapers and magazines to cut out pictures that could be used in your teaching. If you have access to the internet, search for and print out pictures that you may need to use as illustrations in your lessons.
- b Prepare for the written classwork and homework activities:** When preparing your lessons, check the lesson activity requirements. In some instances you will need to write information or draw some diagrams on the board that you will use while you do the interactive whole-class-teaching component of the lesson. Also mark the homework activities as often as you can, so that you can give useful feedback to the learners each day, and be aware of any difficulties learners are having as soon as they become apparent.
- c Prepare to teach the concepts and skills associated with the lesson topic:** Think carefully about what it is that you will teach your learners in the lesson. Prepare a short introduction to the topic, so that you can explain it in simple terms to your learners. Make sure you have prepared for the teaching of the concepts before you teach – you need to be able to explain new Mathematics content and skills to the learners. Be sure you have gone through the oral teaching activities provided in the lesson plans. Also make sure that you have thought about how to use the resources in the lesson effectively. This preparation needs to be done in advance, so that you do not waste time during the lesson. Be sure you are familiar with the sequence of activities in the lesson plan. Prepare yourself to assist learners with any questions they might have during the lesson. Also give some thought to how you will accommodate learners with barriers to learning.

- d Lesson pace:** Think about how much time you will spend on each activity. It is important to plan how you will manage the pace of the lesson carefully; otherwise you will not manage to cover all the lesson content. Not all learners work at the same pace. You need to determine the pace – be guided by the average learner and the recommendations in the lesson plans. Be careful not to slow down to the pace of the slowest learners as this will disadvantage the other learners.
- e Organisation of learners:** Think about how you will organise learners when they do the classwork activities. Will they work alone, in pairs or in small groups? How will you organise the pairs or groups if you choose to use them? You need to organise the learners quickly at the beginning of the lesson, so that you do not waste too much time on this.
- f Inclusive education:** Consider the needs of any learners with barriers to learning in your class, and how best you can support them. The DBE has published some excellent materials to support you in working with learners with learning barriers. Two such publications are:
- Directorate Inclusive Education, Department of Basic Education (2011) *Guidelines for Responding to Learner Diversity in the Classroom Through Curriculum and Assessment Policy Statements*. Pretoria. www.education.gov.za, www.thutong.doe.gov.za/InclusiveEducation.
 - Directorate Inclusive Education, Department of Basic Education (2010) *Guidelines for Inclusive Teaching and Learning. Education White Paper 6. Special needs education: Building an inclusive education and training system*. Pretoria. www.education.gov.za, www.thutong.doe.gov.za/InclusiveEducation.

Lesson Plan Outline

Each lesson plan has several components. Information about each one is given in the table below. This information tells you how to use each of the components of the lesson plans and how they fit together to create a well-paced and properly scaffolded Mathematics lesson each day. You should read this outline as you prepare each lesson until you are fully familiar with the general lesson plan components, pace and structure.

Teacher's notes

These notes include information for the teacher about the CAPS content to be covered in the lesson and the learning objective for the lesson.

A list of the lesson vocabulary is included in the teacher's notes. This is a list of the important mathematical vocabulary used in the lesson. The vocabulary, with explanations and diagrams, is also provided in the bilingual dictionary that is part of your Toolkit. You should go through the lesson vocabulary each day as you prepare for the lesson. These terms are important as they are the language of Mathematics that each learner needs to learn and understand in order to build a solid foundation and understanding of this subject. It is important to explain these words to your learners and encourage learners to use them as well. If you have learners in your class who are not yet comfortable in the Language of Teaching and Learning (LoLT), try and explain the word in a language they understand. Use gestures, pictures or enlist the help of another learner who is familiar with the home language of the learner who is struggling with a language barrier.

Finally, the resources that you should prepare for the days lesson are listed. You need to check what resources you need in advance for each lesson so that you are ready to teach each lesson each day.

Mental mathematics (10 minutes)

This is the first active component of the lesson. We recommend that you take at most 10 minutes to do the mental mathematics activity. The mental mathematics activity consists of a set of questions to drill number facts and basic mathematical strategies that are linked to the day's lesson.

Mental mathematics is not a concrete activity (as the title suggests). Remember a concrete activity uses actual material to scaffold learning. However, if there are learners who need concrete aids to complete the mental mathematics activities, we suggest that you allow them to use their fingers to count on.

- Observe which learners struggle with mental activities, and make sure you spend time later to help them reach the required level of competence by offering remediation activities using concrete aids.
- The answers to the mental mathematics questions are given in the answer column in the lesson plans.

- You should try and complete all of each day's mental mathematics questions, but if you find that your learners struggle to finish these in ten minutes, do a minimum of five questions.

Lesson content – concept development (45 minutes)

This is the second component of the lesson. It is the body of the lesson, in which learners are introduced to the new work planned for the day. We recommend that you actively teach your class for 45 minutes – going through the activities interactively with your learners.

- Activities on the content that you will teach with worked examples and suggested explanations are given. These activities have been carefully sequenced and scaffolded so that they support the teaching of the concepts for that day. You should work through each of these with your class.
- It is important to manage the pace of the lesson carefully otherwise you will not manage to cover all the lesson content. Once you have introduced the new concept, work through Activity 1 of the lesson with the whole class (or with learners in groups). Then immediately move on to the next activity, and provide a reasonable time for the learners to complete Activity 2, but do not wait for the last learner to finish before moving on. If there are further activities, continue pacing yourself in this way, so that you work through all of the activities in each lesson. A few activities are marked as *optional* – these need only be done if you have sufficient time.

Classwork activity and correction of homework (25 minutes)

This is the third component of the lesson. We recommend that you allocate 25 minutes to going over the previous day's homework and giving time to the learners to do the classwork.

First, take a minute or two to reflect on the homework. You might read out answers to all of the homework questions, allow learners/peers to mark the work. Try to check the homework yourself as often as you can. If you notice a question that many learners struggled with, especially if it is important for today's lesson, you could work through it in full with the whole class. Allow learners the opportunity to write corrections as needed.

When you assign the classwork, you could go over one or two of the classwork activities orally with the whole class before allowing the class to complete the activities independently (individually or in groups).

- Learners should do their classwork in their mathematics exercise books.
- Learners should work individually, in pairs and in groups so that they experience working alone as well as with their peers.
- Individual work is so important. Sometimes, in group work, only one or very few learners lead the group, they do all the work and present it to the class for the group. Group work does not guarantee every learner's learning and understanding. Some of the group members may have been left behind without knowing exactly what has been

has done. Learners should first work individually and then discuss what they have done with the rest of the group, based on what they have in their classwork book or worksheets.

- Wrap up the classwork activity each day by giving the learners the answers to the classwork, and allow time for corrections to be written if and when necessary. You should reflect on questions that learners have struggled with if necessary.

The bilingual learner resources contain all of the daily classwork activities.

Homework activity (5 minutes)

This is the fourth component of the lesson. We have allocated five minutes to give you time to tell the learners about the homework each day.

Homework consolidates the content that you have taught each day. Homework also promotes learner writing and development of their mathematical knowledge.

The bilingual learner resources contain all of the daily homework activities.

Reflection (5 minutes)

This is the fifth component of the lesson. You should wrap up the lesson every day by focussing the learners on the content covered and concepts they should have learned.

Week 1

Unit 1 Introduction

In this unit you will be able to focus on the four framework dimensions in the following way:

- **Conceptual understanding:** In this unit conceptual understanding is developed through learners' discussion of solutions and strategies. Learners begin to understand why they are solving problems in a particular way as they verbalise their thought processes and exchange ideas with their peers.
- **Procedural fluency:** Some of the activities in this unit are quite repetitive. This is done intentionally so that learners develop procedural fluency as they become confident in working repeatedly with their times tables.
- **Strategies:** Learners need to understand and develop strategies to solve problems. Learners should be encouraged to verbalise their solutions to problems so that they can see other ways of finding answers.
- **Reasoning:** Learners will be given opportunities to justify their thoughts, solutions and strategies. It is important to allow learners opportunities to discuss and explain their strategies so that they can develop their knowledge and understanding of the concepts through reasoning.

Building a **learning centred classroom** in this unit will involve (amongst other things) attention to:

- **Addressing gaps in learners' knowledge:** In this unit there will be opportunities to address gaps in learners' knowledge as learners will be revising concepts that they have covered previously. As learners work through repeated addition, doubling and multiplication, it will become clear where there are gaps in their understanding. Opportunities are provided to address these gaps through activities and engagement.
- **Connecting topics and concepts:** Concepts such as doubling and repeated addition link to the topic of multiplication, and provide a foundational understanding for the strategies used to solve problems.
- **Problem solving:** In this unit learners are given opportunities to develop their problem solving skills as they discuss word problems, and select strategies to solve them.
- **Applying maths in context:** Word problems enable learners to see the relevance of multiplication in a real-life context. Learners apply maths in context as they select strategies to solve these problems.

Lesson 1: Multiplication tables up to 5

Teacher's notes

This lesson is one of the fully planned lessons to be used to cover the Term 2 curriculum.

CAPS topics: 1.2 Count forwards and backwards; 1.14 Repeated addition leading to multiplication.

Lesson Objective: Learn multiplication tables up to the 5 times table.

Lesson Vocabulary: Multiples, number patterns, counting, extend, difference, increasing, forwards, backwards, calculate, multiply, times.

Resources: Multiplication table (see *Printable Resources*), enlarged multiplication table (for use by the teacher), multiplication cards (see *Printable Resources*).

Date:

Week

Day

1 MENTAL MATHS (10 MINUTES)

	Count forwards in:	Answer
1	2s up to 20	2, 4, 6, 8, 10, 12, 14, 16, 18, 20
2	3s up to 30	3, 6, 9, 12, 15, 18, 21, 24, 27, 30
3	4s up to 40	4, 8, 12, 16, 20, 24, 28, 32, 36, 40
4	5s up to 50	5, 10, 15, 20, 25, 30, 35, 40, 45, 50

2 LESSON CONTENT - CONCEPT DEVELOPMENT (45 MINUTES)

In this lesson learners develop their understanding of the concept of multiplication. A simple array of hats on shelves is used to reintroduce the concept. This leads into the use of the array diagram that will be used in many of the lessons that follow on this topic.

Today we are learning the multiplication tables up to the 5 times table.

Activity 1: Whole class activity

- Draw 3 shelves on the board.
- Draw 2 hats on each shelf.

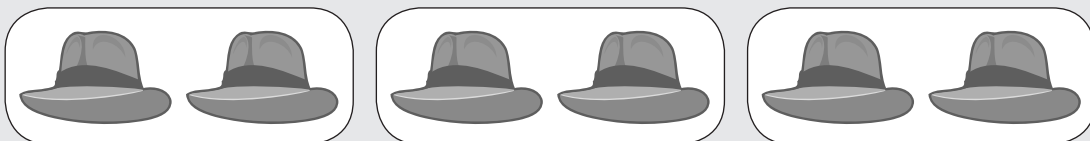

- Ask: **How many hats are there altogether? Write the number sentence and answer in your classwork book.** ($3 \times 2 = 6$ or $2 + 2 + 2 = 6$, 6 hats)
- Let learners present their number sentences and answers.
- *If no one writes $3 \times 2 = 6$, remind learners of the multiplication sign which represents 3 shelves/groups of 2.*

- Ask: **What does the 3 means in $3 \times 2 = 6$?** (The 3 tells us the number of groups.)
- Ask: **What does the 2 means in $3 \times 2 = 6$?** (The 2 tells us the number of hats on one shelf/in one group.)
- Tell learners that calculations like $3 \times 2 = 6$ are multiplication calculations.

Activity 2: Learners work in pairs

- Give pairs of learners the multiplication table.
- Let learners read the 1 times table, i.e. $1 \times 1 = 1$, $2 \times 1 = 2$, $3 \times 1 = 3$... $9 \times 1 = 9$.
- Let learners read the 2 times table, i.e. $1 \times 2 = 2$, $2 \times 2 = 4$, $3 \times 2 = 6$... $9 \times 2 = 18$
- Do the same thing up to 5 times table.
- Let learners count forward in 1s up to 10, 2s up to 20, 3s up to 30, 4s up to 40, 5s up to 50. You should stop them on the way asking questions like: **how many 2s in 14?** (7), **how many 3s in 24?** (8), etc..
- Ask: **What is common between the numbers in the 2 times table and the numbers that appear when you count in 2s?** (The numbers are the same – if you count in 2s, you are counting the multiples of 2.)
- Ask the same question for the other multiples, of 3, 4 and 5.

3 CLASSWORK ACTIVITY AND CORRECTION OF HOMEWORK (25 MINUTES)

NOTE: Give pairs of learners a set of multiplication cards (for the 1 to 5 times tables). In this lesson, the learners should cut up the cards. They should write the answers on the back of each card, to prepare them for use in this and many other lessons. Make sure that they write the correct answers on the backs of the cards!

In this classwork session, learners will first cut and prepare the cards. Then they will do an activity in which they order the cards. After that they will play a multiplication card game using the cards, in pairs.

Rules of the game

- 1 One learner picks up a card (of the 1 to 5 multiplication cards) at a time and reads it out loud.
- 2 The other learner gives the answer.
- 3 Learners take turns to ask and answer questions, checking the answers at the back of the card each time if necessary.

- 1 Learners arrange the multiplication cards in order for the following times tables:

- a $\times 1$
- b $\times 2$
- c $\times 3$
- d $\times 4$
- e $\times 5$

- 2 Play the 1 to 5 multiplication card game. Your teacher will explain the rules.

4 HOMEWORK ACTIVITY (5 MINUTES)

Complete the table:

	Multiplication	Repeated addition	Answer
1	4×3	$3 + 3 + 3 + 3$	(12)
2	5×4	$(4 + 4 + 4 + 4 + 4)$	(20)
3	(4×2)	$2 + 2 + 2 + 2$	(8)
4	5×3	$(3 + 3 + 3 + 3 + 3)$	(15)

5 REFLECTION AND SUMMARY OF LESSON (5 MINUTES)

Call the whole class to attention and summarise the key concepts of the lesson.

Today we have learnt multiplication tables up to the 5 times table.

Lesson 2: Multiplication using array diagrams

Teacher's notes

This lesson is one of the fully planned lessons to be used to cover the Term 2 curriculum.

CAPS topics: 1.2 Count forwards and backwards; 1.14 Repeated addition leading to multiplication; 2.1 Geometric patterns.

Lesson Objective: Represent multiplication pictorially using an array diagram.

Lesson Vocabulary: Multiples, calculate, multiply, times, array, row, column.

Resources: Array diagram (see *Printable Resources*), enlarged array diagram (for use by the teacher), multiplication cards (see *Printable Resources*).

Date:

Week

Day

1 MENTAL MATHS (10 MINUTES)

	Calculate:	Answer			Answer
1	4×3	12	6	6×3	18
2	5×1	5	7	7×5	35
3	7×4	28	8	8×2	16
4	3×2	6	9	6×4	24
5	2×5	10	10	5×3	15

2 LESSON CONTENT - CONCEPT DEVELOPMENT (45 MINUTES)

In this lesson learners use the array diagram in order to solve multiplication calculations which will help them to develop procedural fluency. You should refer to the bilingual dictionary for explanations of the terms array, row and column. It is important that learners know how to use an array table confidently. The learners will also use multiplication cards to help them practise and memorise their multiplication tables.

Today we are learning to represent multiplication pictorially using an array diagram.

Activity 1: Whole class activity

- Give each learner an array diagram.
- Put an enlarged array diagram on the board.
- Write the following multiplication number sentence on the board:
 $3 \times 4 =$
- Ask learners to use the array diagram to help them solve the problem.
- Ask: **How did you use the array diagram to find the answer?** (Hide the diagram to show only the four columns and three rows.)

- Select a learner to come up to the board and explain to the class how they solved the problem.
- Let the learners record the number sentence and answer in their classwork books.
- *The right way of using the array diagram is as follows.*
- Hide away some of the columns by holding a book/paper (1) as shown below. Then, hide away some of the rows, using a second piece of paper/book (2) as shown below.
- Paper 1 below allows 4 dots in a row to be seen. This means we are showing the 4 x table.
- Paper 2 can be moved up and down, to show a different multiple of 4, depending on how many rows are shown.
- e.g. the diagram below shows $3 \times 4 = 12$. (It is not 4×3 . This would be shown by 4 rows with 3 dots in each row.)

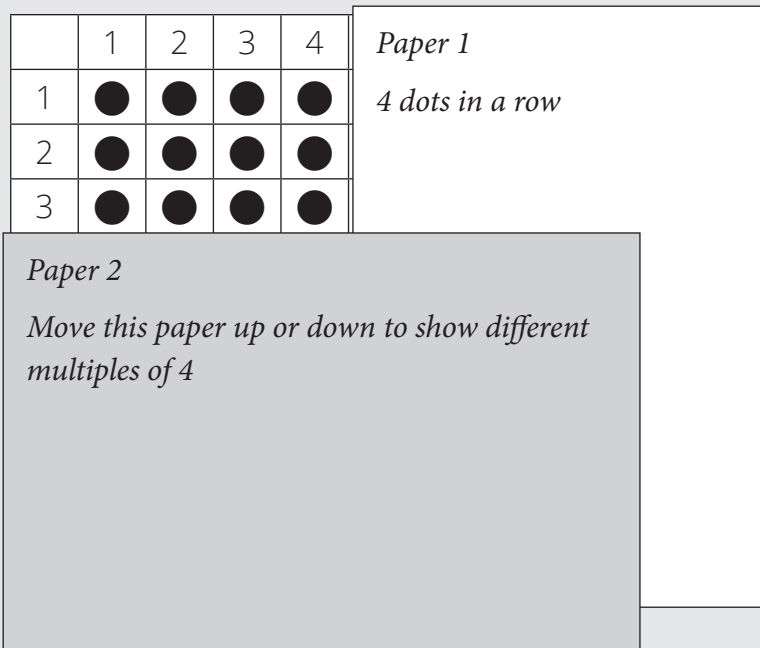

- Repeat the above steps using the array to show:
 $4 \times 4, 5 \times 4, 6 \times 4, 7 \times 4, 8 \times 4, 9 \times 4$
- Help learners to see that they can find the answers by counting in 4s.
- *As the number of groups (represented by the rows) increases, so the answer increases by 4 each time.*
- *The array diagram should always be used in the way shown above, i.e. by hiding unnecessary parts with paper.*

Activity 2: Learners work in pairs

- Give each pair of learners two array diagrams.
- Put an enlarged array diagram on the board.
- Write the following multiplication number sentence on the board:
 $4 \times 9 =$
- Ask learners to use the array diagram to help them solve the problem.

- Select a learner to come up to the board and explain to the class how they solved the problem.
- Encourage learners to verbalise that the number on the left (i.e. 4) counts the number of rows while the number on the right (i.e. 9) counts the number of columns (or the number of dots in a row).

	1	2	3	4	5	6	7	8	9
1	●	●	●	●	●	●	●	●	●
2	●	●	●	●	●	●	●	●	●
3	●	●	●	●	●	●	●	●	●
4	●	●	●	●	●	●	●	●	●

- Ask one of the learners (from each pair) to move the papers so that they now show the product 9×4 . (They should show 9 rows with 4 dots in each row.)
- Ask: **What do you see in the array diagrams of 4×9 and 9×4 ?** (They both have the same number of dots. I know $9 \times 4 = 36$, I can use this knowledge to answer 4×9).
- Put another enlarged array diagram on the board to show 9×4 and discuss the similarities and differences between the two arrays with the class. (Same number of dots, number of dots in the rows and columns are interchanged.)

	1	2	3	4
1	●	●	●	●
2	●	●	●	●
3	●	●	●	●
4	●	●	●	●
5	●	●	●	●
6	●	●	●	●
7	●	●	●	●
8	●	●	●	●
9	●	●	●	●

- Repeat the above steps with the following calculations, 5×6 with 6×5 and 2×7 with 7×2 .
- Give some more examples of multiplications (e.g. 3×8 , 7×6) if the learners work through the activity quickly.

3 CLASSWORK ACTIVITY AND CORRECTION OF HOMEWORK (25 MINUTES)

NOTE: Give pairs of learners a set of multiplication cards. The cards should have been cut up and prepared in the previous lesson so that they can be arranged in order.

Rules of the game

- 1 One learner picks up a card (of the 1 to 5 multiplication cards) at a time and reads it out loud.
- 2 The other learner gives the answer.
- 3 Learners take turns to ask and answer questions, checking the answers at the back of the card each time if necessary.

- 1 Learners arrange the multiplication cards in order for the following times tables:
 - a $\times 1$
 - b $\times 2$
 - c $\times 3$
 - d $\times 4$
 - e $\times 5$
- 2 Play the 1 to 5 multiplication card game. Your teacher will explain the rules.

4 HOMEWORK ACTIVITY (5 MINUTES)

Complete the table:

	Multiplication	Repeated addition	Answer
1	6×4	$4 + 4 + 4 + 4 + 4 + 4$	(24)
2	(4×6)	$6 + 6 + 6 + 6$	(24)
3	(9×5)	$5 + 5 + 5 + 5 + 5 + 5 + 5 + 5 + 5$	(45)
4	5×9	$(9 + 9 + 9 + 9 + 9)$	(45)

5 REFLECTION AND SUMMARY OF LESSON (5 MINUTES)

Call the whole class to attention and summarise the key concepts of the lesson.

Today we have learnt to represent multiplication pictorially using an array diagram.

Lesson 3: The 6 times table

Teacher's notes

This lesson is one of the fully planned lessons to be used to cover the Term 2 curriculum.

CAPS topics: 1.2 Count forwards and backwards; 1.14 Repeated addition leading to multiplication; 2.1 Geometric patterns.

Lesson Objective: Learn the structure of the 6 times table by identifying patterns.

Lesson Vocabulary: Multiples, calculate, multiply, times, array, pattern.

Resources: Array diagram (see *Printable Resources*), enlarged array diagram (for use by the teacher), multiplication cards (see *Printable Resources*).

Date:

Week

Day

1 MENTAL MATHS (10 MINUTES)

	Calculate:	Answer			Answer
1	$6 + 6$	12	6	$54 + 6$	60
2	$18 + 6$	24	7	$12 + 6$	18
3	$36 + 6$	42	8	$60 + 6$	66
4	$48 + 6$	54	9	$24 + 6$	30
5	$30 + 6$	36	10	$42 + 6$	48

2 LESSON CONTENT - CONCEPT DEVELOPMENT (45 MINUTES)

In this lesson learners will use the array diagram in order to learn the 6 times table and recognise the pattern of increasing by 6 each time. This activity shows the connection between repeated addition and multiplication. The learners will use multiplication cards to practise the 6 times table. This practice assists learners to memorise the tables.

Today we are learning the 6 times table.

Activity 1: Learners work in pairs

- Give each pair of learners an array diagram.
- Write the following multiplication number sentence on the board:
 $1 \times 6 =$
- Ask learners to use the array diagram to help them solve the problem, by hiding unnecessary rows and columns in the array.
- *Encourage learners to verbalise that they identified 1 row with 6 dots in the row in the array. Help learners to demonstrate this as shown below:*

	1	2	3	4	5	6
1	●	●	●	●	●	●

- Let learners record the number sentence and answer in their classwork books.
- Learners repeat the above steps using the array to find the value of 2×6 and 3×6 and record the answers in their classwork books.
- Ask: **How many should we add to 3×6 to get the answer for 4×6 ?** (6 because there are 6 dots in a row, we are working out the multiples of 6.)
- Ask: **What do you notice about the answers that you recorded in your classwork book?** (Learners may say that they see that the answers increase by 6 each time).
- *You may need to show learners the array diagrams for each of the calculations (as shown below) to help learners see that each time there is a row of 6 added.*

	1	2	3	4	5	6
1	●	●	●	●	●	●
2	●	●	●	●	●	●

	1	2	3	4	5	6
1	●	●	●	●	●	●
2	●	●	●	●	●	●
3	●	●	●	●	●	●

	1	2	3	4	5	6
1	●	●	●	●	●	●
2	●	●	●	●	●	●
3	●	●	●	●	●	●
4	●	●	●	●	●	●

- You can then help learners to understand that 6 is added each time by writing out the repeated addition sum for each diagram on the board:
 - $6 + 6$ is 12
 - $6 + 6 + 6$ is 18
 - $6 + 6 + 6 + 6$ is 24

Activity 2: Learners work in pairs

- Ask pairs of learners to use their array diagrams to find the answers to the following:
 - 5×6
 - 6×6
 - 7×6
 - 8×6

- 9×6
- Learners need to record the number sentences and answers in their classwork books.
- Ask: **How can we find the answer for each of them?** (By adding 6 to the previous answer.)
- Learners can then use these calculations and answers to create the rest of the 6 times table (up to 9×6).
- Draw this table on the board:
- Complete the table together as a class.

	1	2	3	4	5	6	7	8	9
$\times 6$	(6)	(12)	(18)	(24)	(30)	(36)	(42)	(48)	(54)

- Now draw this flow diagram on the board (you can make it go up to 9×6):
- Complete it together as a class explaining that this is another way in which you can write up the multiples of 6.

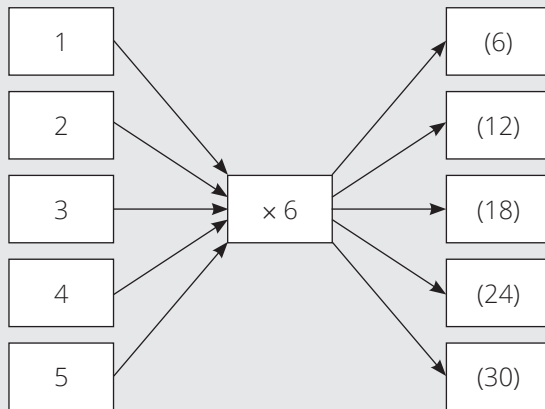

3 CLASSWORK ACTIVITY AND CORRECTION OF HOMEWORK (25 MINUTES)

NOTE: Give each learner, each pair or each group of learners a set of multiplication cards for the **6 times table**. Learners need to prepare these cards (cut them up and write the answers on the back) as they did for the multiplication cards of the 1-5 times tables. There are 4 activities suggested below – select 2 activities to do in this lesson. Keep the cards safe since they will be used in several lessons this term. You should also vary the activities that you choose to use so that the learners don't get bored doing the same activities each time.

Rules of the games

- 1 Learners work alone.
 - a Learners shuffle the cards.
 - b Learners take a number sentence card.
 - c Learners need to say the answer to the number sentence shown on each card to themselves.
 - d Learners check the answers by looking at the back of the card.

- 2** Learners work in pairs.
 - a** Learners shuffle the cards.
 - b** One learner holds up a number sentence for the second learner to read.
 - c** The second learner must read the number sentence and give the answer.
 - d** Learners check the answers by looking at the back of the card.
 - e** The second learner then holds up a number sentence card for the first learner.
 - f** Keep going until all the cards have been read.
- 3** Learners work in groups of 3.
 - a** Learners shuffle the cards.
 - b** Learners lay out the cards with the answers facing up.
 - c** One learner calls out a multiple – any one of the 1 to 9 times tables.
 - d** The other two learners need to find the card with the answer to the multiplication number sentence.
 - e** The first learner to find the card gets to keep the card. The learner who has the most cards at the end wins.
 - f** When there are no more cards, the game can be played again with a different learner calling out the multiplication questions.
- 4** Learners work alone.
 - a** Learners shuffle the cards.
 - b** Learners lay out the cards with the answers facing up.
 - c** Learners think of a number sentence which matches with the answer facing up.
 - d** Learners check the number sentence.

Play the multiplication card game. Your teacher will explain the rules.

4 HOMEWORK ACTIVITY (5 MINUTES)

Complete the table:

	Multiplication	Repeated addition	Answer
1	3×6	$6 + 6 + 6$	(18)
2	4×6	$(6 + 6 + 6 + 6)$	(24)
3	(5×6)	$6 + 6 + 6 + 6 + 6$	(30)
4	6×6	$(6 + 6 + 6 + 6 + 6 + 6)$	(36)
5	(7×6)	$6 + 6 + 6 + 6 + 6 + 6 + 6$	(42)

5 REFLECTION AND SUMMARY OF LESSON (5 MINUTES)

Call the whole class to attention and summarise the key concepts of the lesson.

Today we have learnt the 6 times table.

Lesson 4: The 6 times table

Teacher's notes

This lesson is one of the fully planned lessons to be used to cover the Term 2 curriculum.

CAPS topics: 1.2 Count forwards and backwards; 1.8 Repeated addition leading to multiplication; 1.14 Repeated addition leading to multiplication; 2.1 Geometric patterns

Lesson Objective: Learn the structure of the 6 times table by identifying patterns.

Lesson Vocabulary: Multiples, calculate, multiply, times, array, pattern

Resources: Array diagram (see *Printable Resources*), enlarged array diagram (for use by the teacher), multiplication cards (see *Printable Resources*).

Date:

Week

Day

1 MENTAL MATHS (10 MINUTES)

	Calculate:	Answer			Answer
1	6×1	6	6	6×3	18
2	6×2	12	7	6×2	12
3	6×3	18	8	6×1	6
4	6×4	24	9	6×5	30
5	6×5	30	10	6×4	24

2 LESSON CONTENT - CONCEPT DEVELOPMENT (45 MINUTES)

In this lesson learners will use the array diagram as they continue to learn about the 6 times table and recognise the pattern of increasing by 6 each time. The learners will use multiplication cards to practise the 6 times table. This practice helps learners memorise the tables. The learners prepared the cards of the 6 times tables in the previous lesson. *You should also refer to the tracker for the summary of the problem solving approach used in this lesson.*

Today we are using the 6 times table to solve the problems in context.

Activity 1: Learners work in pairs

- Give pairs of learners a set of multiplication cards for the 6 times table.
- Ask the learners to put the cards in order on their desks.
- In pairs, learners hold up each card from the 6 times table in order to read it out loud to their partner.
- Learners take turns to hold up the cards in order for the other learner to read the number sentence aloud and give the answers.
- Learners check the answers each time.

Activity 2: Whole class activity

- Write the following word problem on the board:
**There are 4 packets
of 6 eggs each.**
How many eggs are there in total?
- *The word problem must be written on three lines as shown above to assist learners to identify the critical information/numbers needed to solve the problem.*
- Read the problem.
- Let the learners read the problem until they read it fluently.
- Underline the numbers (4 and 6).
- Underline the question (How many eggs are there in total?) with a wavy line.
- Let the learners draw four groups of circles, with 6 in each group as shown below.

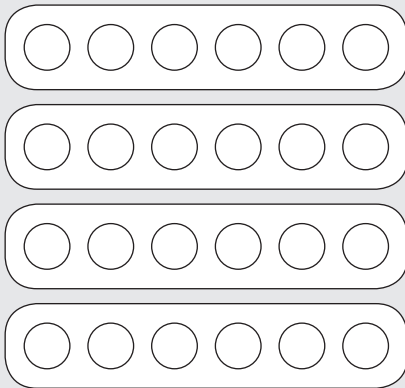

- *It is important that learners are aware of the size of the group in multiplication (i.e. 6 in this question).*
- Let learners write the number sentence.
- Let learners present their number sentence and determine the operation.
- Let the learners solve the number sentence ($4 \times 6 = 24$).
- Ask: **What is the answer for the word problem?** (There are **24 eggs.**)
- *Learners must to answer with the unit, 24 eggs.*

Activity 3: Whole class activity

- Let learners solve the problem below by following the same steps as in Activity 2. Give the learners array diagrams to work with.
**There are 7 plastic bags
that can hold 6 mangoes each.**
How many mangoes are there in total?
- *The only difference between activity 1 and activity 2 is that learners use an array diagram in activity 2 instead of drawing circles.*
- The array diagram for this problem is as follows.

	1	2	3	4	5	6
1	●	●	●	●	●	●
2	●	●	●	●	●	●
3	●	●	●	●	●	●
4	●	●	●	●	●	●
5	●	●	●	●	●	●
6	●	●	●	●	●	●
7	●	●	●	●	●	●

- The number sentence is $7 \times 6 = 42$.
- Confirm that the answer is 42 mangoes.

3 CLASSWORK ACTIVITY AND CORRECTION OF HOMEWORK (25 MINUTES)

NOTE: Give each learner, each pair or each group of learners a set of multiplication cards for the **6 times table**. Learners should have prepared these cards in the previous lesson. There are 4 activities suggested below – select 2 activities to do in this lesson. These activities will be used again in later lessons, so you should keep the cards safe. You should also vary the activities that you choose to use so that the learners don't get bored doing the same activities each time.

Rules of the game

- Learners work alone.
 - Learners shuffle the cards.
 - Learners take a number sentence card.
 - Learners need to say the answer to the number sentence shown on each card to themselves.
 - Learners check the answers by looking at the back of the card.
- Learners work in pairs.
 - Learners shuffle the cards.
 - One learner holds up a number sentence for the second learner to read.
 - The second learner must read the number sentence and give the answer.
 - Learners check the answers by looking at the back of the card.
 - The second learner then holds up a number sentence card for the first learner.
 - Keep going until all the cards have been read.
- Learners work in groups of 3.
 - Learners shuffle the cards.
 - Learners lay out the cards with the answers facing up.
 - One learner calls out a multiple – any one of the 1 to 9 times tables.
 - The other two learners need to find the card with the answer to the multiplication number sentence.

- e The first learner to find the card gets to keep the card. The learner who has the most cards at the end wins.
 - f When there are no more cards, the game can be played again with a different learner calling out the multiplication questions.
- 4** Learners work alone.
- a Learners shuffle the cards.
 - b Learners lay out the cards with the answers facing up.
 - c Learners provide a number sentence which matches with the answer facing up.
 - d Learners check that they gave a correct number sentence.

Play the multiplication card game. Your teacher will explain the rules.

4 HOMEWORK ACTIVITY (5 MINUTES)

Complete the table:

	Multiplication	Repeated addition	Answer
1	9×6	$6 + 6 + 6 + 6 + 6 + 6 + 6 + 6 + 6$	(54)
2	8×6	$(6 + 6 + 6 + 6 + 6 + 6 + 6 + 6)$	(48)
3	(2×6)	$6 + 6$	(12)
4	3×6	$(6 + 6 + 6)$	(18)
5	(4×6)	$6 + 6 + 6 + 6$	(24)

5 REFLECTION AND SUMMARY OF LESSON (5 MINUTES)

Call the whole class to attention and summarise the key concepts of the lesson.

Today we have learnt the 6 times table.

Lesson 5: Consolidation

Teacher's notes

This lesson allows for consolidation of the previous days' lesson content.

CAPS topics: 1.2 Count forwards and backwards; 1.14 Repeated addition leading to multiplication; 2.1 Geometric patterns.

Lesson Objective: Revise multiplication (the 5 and 6 times tables).

Lesson Vocabulary: Multiples, calculate, multiply, times, array, pattern.

Resources: Multiplication cards (see *Printable Resources*).

Date: _____ Week _____ Day _____

1 NOTES FOR THE TEACHER RELATING TO THIS WEEK'S WORK

This week the learners learnt about multiplication, focusing on the 5 and 6 times tables.

2 POSSIBLE MISCONCEPTIONS LINKED TO THE WEEK'S WORK

Learners need many opportunities to make connections between repeated addition and multiplication, so encourage learners to verbalise this as part of their consolidation. Make sure that learners understand that a multiplication number sentence such as 3×4 means that there are 3 groups of 4. Be sure that learners don't confuse addition with multiplication – make sure they know the difference between the signs and know how to read them correctly. They need to know the difference between 3×4 and $3 + 4$.

3 CLASSWORK/HOMEWORK – COMPLETE THIS WEEK'S CLASSWORK AS NEEDED

Today we are going over what we learned this week. We are learning more about multiplication.

NOTE: Question 3 of the activity calls for the learners to play the multiplication card game. Learners need the cards for the 5 **and** 6 times tables for the game today.

Rules of the game

Learners work in pairs.

- a Learners shuffle the cards.
- b Learners lay out the cards with the answers facing up.
- c The first learner selects a card for the second learner.
- d The second learner must say whether the answer is part of the 5 or 6 times table.
- e The second learner must also say either the number that comes before the answer shown, or the number that comes after the number shown.
- f For example: *If the number 12 is shown, the second learner will say "It is from the 6 times table and the number before it is 6."*

g The second learner then selects a card for the first learner, and the game proceeds in the same way.

4 ADDITIONAL ACTIVITIES FOR CONSOLIDATION – SEE LEARNER RESOURCES

1 Complete the table:

	Multiplication	Repeated addition	Answer
a	2×5	$5 + 5$	(10)
b	3×5	$(5 + 5 + 5)$	(15)
c	(4×5)	$5 + 5 + 5 + 5$	(20)
d	5×5	$(5 + 5 + 5 + 5 + 5)$	(25)
e	(6×5)	$5 + 5 + 5 + 5 + 5 + 5$	(30)
f	7×5	$(5 + 5 + 5 + 5 + 5 + 5 + 5)$	(35)
g	(8×5)	$5 + 5 + 5 + 5 + 5 + 5 + 5 + 5$	40
h	(9×5)	$5 + 5 + 5 + 5 + 5 + 5 + 5 + 5 + 5$	45

2 Complete the table:

	Multiplication	Repeated addition	Answer
a	2×6	$6 + 6$	(12)
b	3×6	$(6 + 6 + 6)$	(18)
c	(4×6)	$6 + 6 + 6 + 6$	(24)
d	5×6	$(6 + 6 + 6 + 6 + 6)$	(30)
e	(6×6)	$6 + 6 + 6 + 6 + 6 + 6$	(36)
f	7×6	$(6 + 6 + 6 + 6 + 6 + 6 + 6)$	(42)
g	(8×6)	$6 + 6 + 6 + 6 + 6 + 6 + 6 + 6$	48
h	(9×6)	$6 + 6 + 6 + 6 + 6 + 6 + 6 + 6 + 6$	54

3 Complete the flow diagrams:

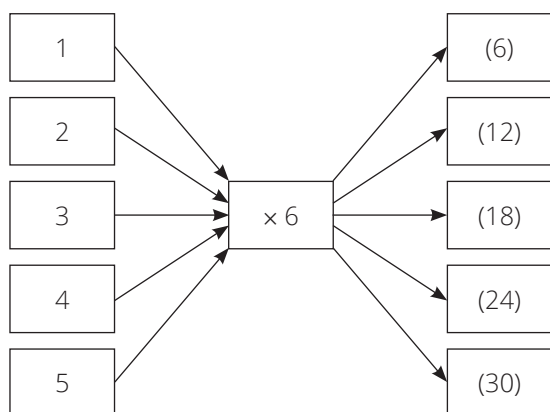
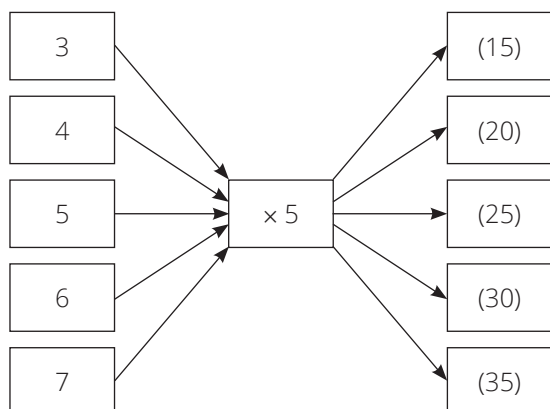

4 Play the multiplication card game. Your teacher will explain the rules.

5 REFLECTION AND SUMMARY OF LESSON

Call the whole class to attention and summarise the key concepts of the lesson.

Today we have revised multiplication (the 5 and 6 times tables).

Week 2

Lesson 6: The 7 times table

Teacher's notes

This lesson is one of the fully planned lessons to be used to cover the Term 2 curriculum.

CAPS topics: 1.2 Count forwards and backwards; 1.14 Repeated addition leading to multiplication; 2.1 Geometric patterns.

Lesson Objective: Learn the structure of the 7 times table by identifying patterns.

Lesson Vocabulary: Multiples, calculate, multiply, times, array, pattern.

Resources: Array diagram (see *Printable Resources*), enlarged array diagram (for use by the teacher), multiplication cards (see *Printable Resources*).

Date:

Week

Day

1 MENTAL MATHS (10 MINUTES)

	Calculate:	Answer			Answer
1	$14 + 7$	21	6	$42 + 7$	49
2	$21 + 7$	28	7	$56 + 7$	63
3	$7 + 7$	14	8	$49 + 7$	56
4	$28 + 7$	35	9	$35 + 7$	42
5	$0 + 7$	7	10	$63 + 7$	70

2 LESSON CONTENT - CONCEPT DEVELOPMENT (45 MINUTES)

In this lesson learners will use the array diagram in order to learn the 7 times table and recognise the pattern of increasing by 7 each time. This activity shows the connection between repeated addition and multiplication. The learners will use multiplication cards to practise the 7 times table. This practice assists learners to memorise the tables.

Today we are learning the 7 times table.

Activity 1: Learners work in pairs

- Give each pair of learners an array diagram.
- Write the following multiplication number sentence on the board:
 $1 \times 7 =$
- Ask learners to use the array diagram to help them solve the problem, by hiding unnecessary rows and columns in the array.

- Encourage learners to verbalise that they identified 1 row with 7 dots in the row as shown in the diagram.

	1	2	3	4	5	6	7
1	●	●	●	●	●	●	●

- Let learners record the number sentence and answer in their classwork books.
- Learners repeat the above steps using the array to find the value of 2×7 , 3×7 and 4×7 and record the answers in their classwork books.
- Ask: **What do you notice about the answers that you recorded in your classwork book?** (Learners may say that they see that the answers increase by 7 each time.)
- You may need to show learners the array diagrams for each of the calculations (as shown below) to help learners see that each time there is a row of 7 added.

	1	2	3	4	5	6	7
1	●	●	●	●	●	●	●
2	●	●	●	●	●	●	●

	1	2	3	4	5	6	7
1	●	●	●	●	●	●	●
2	●	●	●	●	●	●	●
3	●	●	●	●	●	●	●

	1	2	3	4	5	6	7
1	●	●	●	●	●	●	●
2	●	●	●	●	●	●	●
3	●	●	●	●	●	●	●
4	●	●	●	●	●	●	●

- You can then help learners to understand that 7 is added each time by writing out the repeated addition sum for each diagram on the board:
 - $7 + 7$ is 14
 - $7 + 7 + 7$ is 21
 - $7 + 7 + 7 + 7$ is 28

Activity 2: Learners work in pairs

- Ask pairs of learners to use their array diagrams to find the answers to the following:
 - 5×7
 - 6×7
 - 7×7
 - 8×7
 - 9×7

- Learners need to record the number sentences and answers in their classwork books.
- Learners can then use these calculations and answers to create the rest of the 7 times table (up to 9×7).
- Draw this table on the board:
- Complete the table together as a class.

	1	2	(3)	4	5	6	7	(8)	9
$\times 7$	(7)	(14)	21	(28)	(35)	(42)	(49)	56	(63)

- Now draw this flow diagram on the board (you can make it go up to 9×7):
- Complete it together as a class explaining that this is another way in which you can write up the multiples of 7.

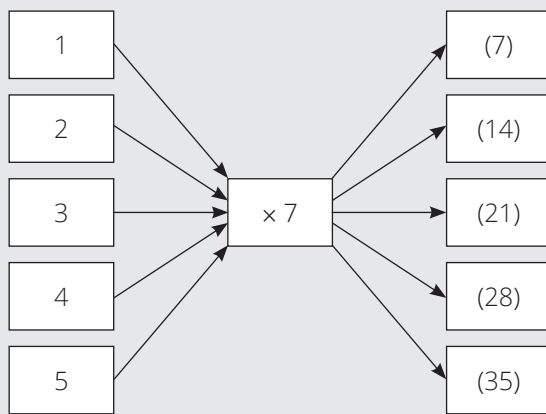

3 CLASSWORK ACTIVITY AND CORRECTION OF HOMEWORK (25 MINUTES)

NOTE: Give each learner, each pair or each group of learners a set of multiplication cards for the **7 times table**. Learners need to prepare these cards (cut them up and write the answers on the back) as they did for the multiplication cards of the other times tables in previous lessons. There are 4 activities suggested below – you can do all of them if you have enough time, otherwise select 2 or 3 activities to do in this lesson.

Rules of the game

- 1 Learners work in pairs.
 - a Learners shuffle the cards.
 - b One learner holds up a number sentence for the second learner to read.
 - c The second learner must read the number sentence and give the answer.
 - d The second learner then holds up a number sentence card for the first learner.
 - e Keep going until all the cards have been read.
- 2 Learners work in pairs.
 - a Learners shuffle the cards.
 - b Learners each hold up a number sentence card.
 - c Learners need to say the answer to each other's cards.
 - d Learners then each select another number sentence card to hold up.

- 3** Learners work in groups of 3.
- Learners shuffle the cards.
 - Learners lay out the cards with the answers facing up.
 - One learner calls out a multiplication number sentence.
 - The other two learners need to find the card with the answer to the multiplication number sentence.
 - The first learner to find the correct card gets to keep the card.
 - When there are no more cards left, the game can be played again with a different learner calling out the multiplication number sentences.
- 4** Learners work in pairs.
- Learners shuffle the cards.
 - Learners lay out the cards with the answers facing up.
 - One learner selects a card.
 - The other learner must look at the answer and give a multiplication number sentence which has that answer.
 - If the learner says the correct multiplication number sentence then they can keep the card.
 - The second learner then selects a card for the first learner.

Play the multiplication card game. Your teacher will explain the rules.

4 HOMEWORK ACTIVITY (5 MINUTES)

Complete the table:

	Multiplication	Repeated addition	Answer
1	2×7	$7 + 7$	(14)
2	4×7	$(7 + 7 + 7 + 7)$	(28)
3	(5×7)	$7 + 7 + 7 + 7 + 7$	(35)
4	8×7	$(7 + 7 + 7 + 7 + 7 + 7 + 7 + 7)$	(56)
5	(7×7)	$7 + 7 + 7 + 7 + 7 + 7 + 7$	(49)

5 REFLECTION AND SUMMARY OF LESSON (5 MINUTES)

Call the whole class to attention and summarise the key concepts of the lesson.

Today we have learnt the 7 times table.

Lesson 7: The 7 times table

Teacher's notes

This lesson is one of the fully planned lessons to be used to cover the Term 2 curriculum.

CAPS topics: 1.2 Count forwards and backwards; 1.8 Repeated addition leading to multiplication; 1.14 Repeated addition leading to multiplication; 2.1 Geometric patterns.

Lesson Objective: Learn the structure of the 7 times table by identifying patterns.

Lesson Vocabulary: Multiples, calculate, multiply, times, array, pattern.

Resources: Array diagram (see *Printable Resources*), enlarged array diagram (for use by the teacher), multiplication cards (see *Printable Resources*).

Date:

Week

Day

1 MENTAL MATHS (10 MINUTES)

	Calculate:	Answer			Answer
1	7×1	7	6	7×3	21
2	7×2	14	7	7×2	14
3	7×3	21	8	7×1	7
4	7×4	28	9	7×5	35
5	7×5	35	10	7×4	28

2 LESSON CONTENT - CONCEPT DEVELOPMENT (45 MINUTES)

In this lesson learners will use the array diagram as they continue to learn about the 7 times table and recognise the pattern of increasing by 7 each time. The learners will use multiplication cards to practise the 7 times table. This practice helps learners memorise the tables. The learners prepared the cards of the 7 times tables in the previous lesson.

You should also refer to the tracker for the summary of the problem solving approach used in this lesson.

Today we are using the 7 times table to solve the problems in context.

Activity 1: Learners work in pairs

- Give pairs of learners a set of multiplication cards for the 7 times table.
- Ask the learners to put the cards in order on their desks.
- In pairs, learners hold up each card from the 7 times table in order to read it out loud to their partner.
- Learners take turns to hold up the cards in order for the other learner to read the number sentence aloud and give the answers.
- Learners check the answers each time.

Activity 2: Whole class activity

- Give the learners array diagrams to work with.
- Write the following problem on the board:
**There are 8 netball teams
of 7 players each.**
How many players are there in total?
- *The word problem must be written on three lines as shown above to assist learners to identify the critical information/numbers needed to solve the problem.*
- Read the problem.
- Let the learners read the problem until they read it fluently.
- Underline the numbers (8 and 7).
- Underline the question (How many people are there in total?) with a wavy line.
- Let learners work out the answer using their array diagrams.
- Let learners present their ideas about how to solve the problem.
- Ask learner to write the number sentence:
 $8 \times 7 = 56$
- Read the number sentence together several times, making the connection between the numbers in the number sentence and the story of the word problem.
- Confirm that the answer is 56 players.

Activity 3: Whole class activity

- Give the learners array diagrams to work with.
- Write the following problem on the chalkboard:
**There are 3 post boxes
that have 7 letters each.**
How many letters are there in total?
- *The word problem must be written on three lines as shown above to assist learners to identify the critical information/numbers needed to solve the problem.*
- Read the problem.
- Let the learners read the problem until they read it fluently.
- Underline the numbers (3 and 7).
- Underline the question (How many letters are there in total?) with a wavy line.
- Let learners work out the answer using their array diagrams.
- Let learners present their ideas about how to solve the problem.
- Ask a learner to write the number sentence:
 $3 \times 7 = 21$
- Read the number sentence together several times, making the connection between the numbers in the number sentence and the story of the word problem.
- Confirm that the answer is 21 letters.

3 CLASSWORK ACTIVITY AND CORRECTION OF HOMEWORK (25 MINUTES)

NOTE: Give each learner, each pair or each group of learners a set of multiplication cards for the **7 times table**. Learners should have prepared these cards in the previous lesson. There are 4 activities suggested below – you can do all of them if you have enough time, otherwise select 2 or 3 activities to do in this lesson.

Rules of the game

- 1 Learners work in pairs.
 - a Learners shuffle the cards.
 - b One learner holds up a number sentence for the second learner to read.
 - c The second learner must read the number sentence and give the answer.
 - d The second learner then holds up a number sentence card for the first learner.
 - e Keep going until all the cards have been read.
- 2 Learners work in pairs.
 - a Learners shuffle the cards.
 - b Learners each hold up a number sentence card.
 - c Learners need to say the answer to each other's cards.
 - d Learners then each select another number sentence card to hold up.
- 3 Learners work in groups of 3.
 - a Learners shuffle the cards.
 - b Learners lay out the cards with the answers facing up.
 - c One learner calls out a multiplication number sentence.
 - d The other 2 learners need to find the card with the answer to the multiplication number sentence.
 - e The first learner to find the correct card gets to keep the card.
 - f When there are no more cards, the game can be played again with a different learner calling out the multiplication number sentences.
- 4 Learners work in pairs.
 - a Learners shuffle the cards.
 - b Learners lay out the cards with the answers facing up.
 - c One learner selects a card.
 - d The other learner must look at the answer and say the correct multiplication number sentence.
 - e If the learner says the correct multiplication number sentence they can keep the card.
 - f The second learner then selects a card for the first learner.

Play the multiplication card game. Your teacher will explain the rules.

4 HOMEWORK ACTIVITY (5 MINUTES)

Complete the table:

	Multiplication	Repeated addition	Answer
1	5×7	$7 + 7 + 7 + 7 + 7$	(35)
2	9×7	$(7 + 7 + 7 + 7 + 7 + 7 + 7 + 7 + 7)$	(63)
3	(6×7)	$7 + 7 + 7 + 7 + 7 + 7$	(42)
4	2×7	$(7 + 7)$	(14)
5	(3×7)	$7 + 7 + 7$	(21)

5 REFLECTION AND SUMMARY OF LESSON (5 MINUTES)

Call the whole class to attention and summarise the key concepts of the lesson.

Today we have learnt the 7 times table.

Lesson 8: Assessment

Teacher's notes

This lesson should be used for assessment of the content covered in this unit to date.

CAPS topics: 1.2 Count forwards and backwards; 1.14 Repeated addition leading to multiplication; 2.1 Geometric patterns.

Resources: Printable assessment in teacher's resources.

Date: _____ Week _____ Day _____

1 SETTLE THE CLASS AND ADMINISTER THE ASSESSMENT. (45 MINUTES)

The assessment for today is linked to the work covered in the unit to date.

You will find the printable version of the assessment in the teacher's resource pack.

Take some time to do the *oral assessment* (see checklist below).

2 DISCUSS ASSESSMENT ITEMS WITH THE CLASS (45 MINUTES)

Take in the learners' work when they are done.

There should be time for you to discuss a few of the items with the class:

- use this opportunity to reflect on different methods used by learners (allow some learners to write their solutions on the board).
- speak about misconceptions that may have arisen in learners' responses.

3 ASSESSMENT

WRITTEN ASSESSMENT (27)

1 Complete the table: (17)

	Multiplication	Repeated addition	Answer
a	4×5	$5 + 5 + 5 + 5$	(20)
b	3×6	$(6 + 6 + 6)$	(18)
c	(9×7)	$7 + 7 + 7 + 7 + 7 + 7 + 7 + 7 + 7$	(63)
d	2×6	$(6 + 6)$	(12)
e	(3×7)	$7 + 7 + 7$	(21)
f	7×5	$(5 + 5 + 5 + 5 + 5 + 5 + 5)$	(35)
g	(9×6)	$6 + 6 + 6 + 6 + 6 + 6 + 6 + 6 + 6$	(54)
h	8×7	$(7 + 7 + 7 + 7 + 7 + 7 + 7 + 7)$	(56)
i	(6×5)	$5 + 5 + 5 + 5 + 5 + 5$	(30)

2 Complete the flow diagrams:

(10)

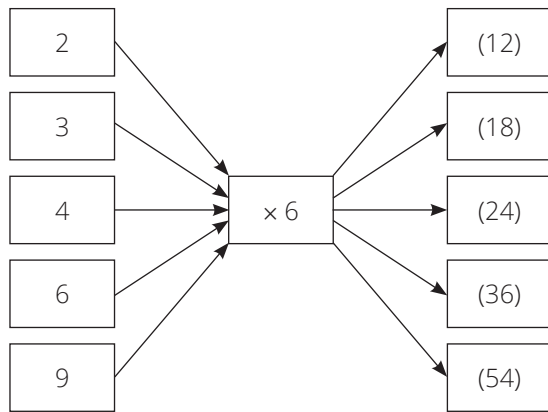
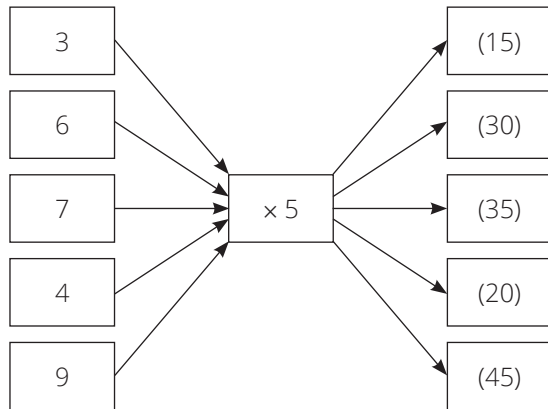

ORAL ASSESSMENT

CAPS: Number, operations and relationships: Multiples - counting in patterns.		Mark: 7
Activity: Assess the learners' ability to count forwards and backwards in 1s, 2s, 3s, 4s, 5s, 6s, and 7s.		
Mark	Criteria - Checklist: (1 mark for each criterion achieved)	
1	Can count verbally forwards and backwards in 1s up to 1×9	
1	Can count verbally forwards and backwards in 2s up to 2×9	
1	Can count verbally forwards and backwards in 3s up to 3×9	
1	Can count verbally forwards and backwards in 4s up to 4×9	
1	Can count verbally forwards and backwards in 5s up to 5×9	
1	Can count verbally forwards and backwards in 6s up to 6×9	
1	Can count verbally forwards and backwards in 7s up to 7×9	

Lesson 9: The 8 times table

Teacher's notes

This lesson is one of the fully planned lessons to be used to cover the Term 2 curriculum.

CAPS topics: 1.2 Count forwards and backwards; 1.14 Repeated addition leading to multiplication; 2.1 Geometric patterns.

Lesson Objective: Learn the structure of the 8 times table by identifying patterns.

Lesson Vocabulary: Multiples, calculate, multiply, times, array, pattern.

Resources: Array diagram (see *Printable Resources*), enlarged array diagram (for use by the teacher), multiplication cards (see *Printable Resources*).

Date:

Week

Day

1 MENTAL MATHS (10 MINUTES)

	Calculate:	Answer			Answer
1	$24 + 8$	32	6	$56 + 8$	64
2	$8 + 8$	16	7	$48 + 8$	56
3	$0 + 8$	8	8	$40 + 8$	48
4	$16 + 8$	24	9	$64 + 8$	72
8	$32 + 8$	40	10	$72 + 8$	80

2 LESSON CONTENT - CONCEPT DEVELOPMENT (45 MINUTES)

In this lesson learners will use the array diagram in order to learn the 8 times table and recognise the pattern of increasing by 8 each time. This activity shows the connection between repeated addition and multiplication. The learners will use multiplication cards to practise the 8 times table. This practice assists learners to memorise the tables.

Today we are learning the 8 times table.

Activity 1: Learners work in pairs

- Give each pair of learners an array diagram.
- Write the following multiplication number sentence on the board:
 $1 \times 8 =$
- Ask learners to use the array diagram to help them solve the problem, by hiding unnecessary rows and columns in the array.
- *Encourage learners to verbalise that they identified 1 row with 8 dots in the row as shown in the diagram.*

	1	2	3	4	5	6	7	8
1	●	●	●	●	●	●	●	●

- Let learners record the number sentence and answer in their classwork books.
- Learners should repeat the above steps using the array to find the value of 2×8 , 3×8 and 4×8 and record the answers in their classwork books.
- Ask: **What do you notice about the answers that you recorded in your classwork book?** (Learners may say that they see that the answers increase by 8 each time).
- *You may need to show learners the array diagrams for each of the calculations (as shown below) to help learners see that each time there is a row of 8 added.*

	1	2	3	4	5	6	7	8
1	●	●	●	●	●	●	●	●
2	●	●	●	●	●	●	●	●

	1	2	3	4	5	6	7	8
1	●	●	●	●	●	●	●	●
2	●	●	●	●	●	●	●	●
3	●	●	●	●	●	●	●	●

	1	2	3	4	5	6	7	8
1	●	●	●	●	●	●	●	●
2	●	●	●	●	●	●	●	●
3	●	●	●	●	●	●	●	●
4	●	●	●	●	●	●	●	●

- You can then help learners to understand that 8 is added each time by writing out the repeated addition sum for each diagram on the board:
 - $8 + 8$ is 16
 - $8 + 8 + 8$ is 24
 - $8 + 8 + 8 + 8$ is 32

Activity 2: Learners work in pairs

- Ask pairs of learners to use their array diagrams to find the answers to the following:
 - 5×8
 - 6×8
 - 7×8
 - 8×8
 - 9×8
- Learners need to record the number sentences and answers in their classwork books.

- Ask: **How can we find the answer for each of them?** (By adding 8 to the previous answer.)
- Learners can then use these calculations and answers to create the rest of the 8 times table (up to 9×8).
- Draw this table on the board:
- Complete the table together as a class.

	1	2	3	4	(5)	6	(7)	8	(9)
$\times 8$	(8)	(16)	(24)	(32)	40	(48)	56	(64)	72

- Now draw this flow diagram on the board (you can make it go up to 9×8):
- Complete it together as a class explaining that this is another way in which you can write up the multiples of 8.

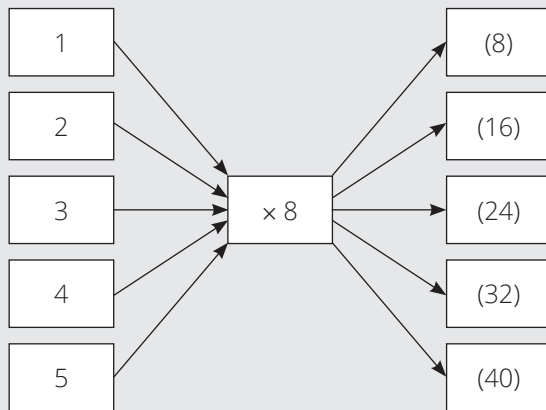

3 CLASSWORK ACTIVITY AND CORRECTION OF HOMEWORK (25 MINUTES)

NOTE: Give each learner, each pair or each group of learners a set of multiplication cards for the **8 times table**. Learners need to prepare these cards (cut them up and write the answers on the back) as they did for the multiplication cards of the other times tables. There are 4 activities suggested below – you can do all of them if you have enough time, otherwise select 2 or 3 activities to do in this lesson.

Rules of the game

- 1 Learners work in pairs.
 - a Learners shuffle the cards.
 - b One learner holds up a number sentence for the second learner to read.
 - c The second learner must read the number sentence and give the answer.
 - d The second learner then holds up a number sentence card for the first learner.
 - e Keep going until all the cards have been read.
- 2 Learners work in pairs.
 - a Learners shuffle the cards.
 - b Learners each hold up a number sentence card.
 - c Learners need to say the answer to each other's cards.
 - d Learners then each select another number sentence card to hold up.

- 3** Learners work in groups of 3.
- Learners shuffle the cards.
 - Learners lay out the cards with the answers facing up.
 - One learner calls out a multiplication number sentence.
 - The other 2 learners need to find the card with the answer to the multiplication number sentence.
 - The first learner to find the correct card gets to keep the card.
 - When there are no more cards, the game can be played again with a different learner calling out the multiplication number sentences.
- 4** Learners work in pairs.
- Learners shuffle the cards.
 - Learners lay out the cards with the answers facing up.
 - One learner selects a card.
 - The other learner must look at the answer and say the correct multiplication number sentence.
 - If the learner says the correct multiplication number sentence they can keep the card.
 - The second learner then selects a card for the first learner.

Play the multiplication card game. Your teacher will explain the rules.

4 HOMEWORK ACTIVITY (5 MINUTES)

Complete the table:

	Multiplication	Repeated addition	Answer
1	4×8	$8 + 8 + 8 + 8$	(32)
2	6×8	$(8 + 8 + 8 + 8 + 8 + 8)$	(48)
3	(3×8)	$8 + 8 + 8$	(24)
4	9×8	$(8 + 8 + 8 + 8 + 8 + 8 + 8 + 8 + 8)$	(72)
5	(5×8)	$8 + 8 + 8 + 8 + 8$	(40)

5 REFLECTION AND SUMMARY OF LESSON (5 MINUTES)

Call the whole class to attention and summarise the key concepts of the lesson.

Today we have learnt the 8 times table.

Lesson 10: Consolidation

Teacher's notes

This lesson allows for consolidation of the previous days' lesson content.

CAPS topics: 1.2 Count forwards and backwards; 1.14 Repeated addition leading to multiplication; 2.1 Geometric patterns.

Lesson Objective: Revise multiplication (the 7, 8 and 9 times tables).

Lesson Vocabulary: Multiples, calculate, multiply, times, array, pattern.

Resources: Multiplication cards (see *Printable Resources*).

Date: _____ Week _____ Day _____

1 NOTES FOR THE TEACHER RELATING TO THIS WEEK'S WORK

This week the learners learnt about multiplication, focusing on the 7 and 8 times tables.

2 POSSIBLE MISCONCEPTIONS LINKED TO THE WEEK'S WORK

Learners need many opportunities to make connections between repeated addition and multiplication, so encourage learners to verbalise this as part of their consolidation. Make sure that learners understand that a multiplication number sentence such as 5×7 means that there are 5 groups of 7. Be sure that learners don't try to add $5 + 7$.

3 CLASSWORK/HOMEWORK - COMPLETE THIS WEEK'S CLASSWORK AS NEEDED

Today we are going over what we learned this week. We are learning more about multiplication.

NOTE: Question 3 of the activity calls for the learners to play the multiplication card game. Learners need the cards for the 8 and 8 times tables for the game today.

Rules of the game

Learners work in pairs.

- a Learners shuffle the cards.
- b Learners lay out the cards with the answers facing up.
- c The first learner selects a card for the second learner.
- d The second learner must say whether the answer is part of the 7 or 8 times table.
- e The second learner must also say either the number that comes before the answer shown, or the number that comes after the number shown.
- f For example: *If the number 40 is shown, the second learner will say "It is from the 8 times table and the number before it is 32"*
- g The second learner then selects a card for the first learner, and the game proceeds in the same way.

Play the multiplication card game. Your teacher will explain the rules.

4 ADDITIONAL ACTIVITIES FOR CONSOLIDATION – SEE LEARNER RESOURCES

1 Complete the flow diagrams:

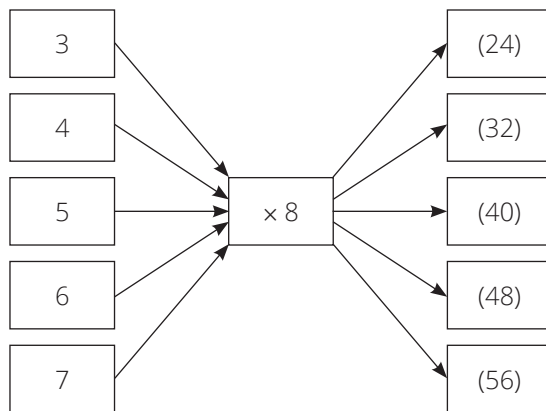
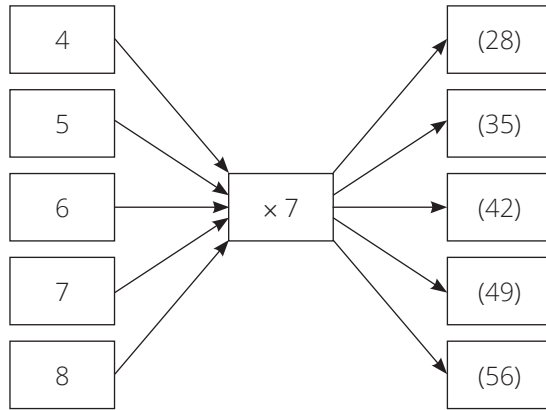

2 Complete the tables:

a

	4	(5)	6	7	8
$\times 7$	(28)	35	(42)	(49)	(56)

b

	3	4	5	(6)	7
$\times 8$	(24)	(32)	(40)	48	(56)

3 Play the multiplication card game in pairs. Your teacher will explain the rules.

5 REFLECTION AND SUMMARY OF LESSON

Call the whole class to attention and summarise the key concepts of the lesson.

Today we have revised multiplication (the 7 and 8 times tables).

Week 3

Lesson 11: The 9 times table

Teacher's notes

This lesson is one of the fully planned lessons to be used to cover the Term 2 curriculum.

CAPS topics: 1.2 Count forwards and backwards; 1.14 Repeated addition leading to multiplication; 2.1 Geometric patterns.

Lesson Objective: Learn the structure of the 9 times table by identifying patterns.

Lesson Vocabulary: Multiples, calculate, multiply, times, array, pattern.

Resources: Array diagram (see *Printable Resources*), enlarged array diagram (for use by the teacher), multiplication cards (see *Printable Resources*).

Date: _____ Week _____ Day _____

1 MENTAL MATHS (10 MINUTES)

	Calculate:	Answer			Answer
1	$18 + 9$	27	9	$54 + 9$	63
2	$27 + 9$	36	7	$63 + 9$	72
3	$36 + 9$	45	8	$45 + 9$	54
4	$0 + 9$	9	9	$72 + 9$	81
5	$9 + 9$	18	10	$81 + 9$	90

2 LESSON CONTENT - CONCEPT DEVELOPMENT (45 MINUTES)

In this lesson learners will use the array diagram in order to learn the 9 times table and recognise the pattern of increasing by 9 each time. This activity shows the connection between repeated addition and multiplication. The learners will use multiplication cards to practise the 9 times table. This practice assists learners to memorise the tables.

Today we are learning the 9 times table.

Activity 1: Learners work in pairs

- Give each pair of learners an array diagram.
- Write the following multiplication number sentence on the board:
 $1 \times 9 =$
- Ask learners to use the array diagram to help them solve the problem, by hiding unnecessary rows and columns in the array.

- Encourage learners to verbalise that they identified 1 row with 9 dots in the row in the array. Help learners to demonstrate this as shown below:

	1	2	3	4	5	6	7	8	9
1	●	●	●	●	●	●	●	●	●

- Let learners record the number sentence and answer in their classwork books.
- Learners repeat the above steps using the array to find the value of 2×9 , 3×9 and 4×9 and record the answers in their classwork books.
- Ask: **What do you notice about the answers that you recorded in your classwork book?** (Learners are expected to say that they see that the answers increase by 9 each time).
- You may need to show learners the array diagrams for each of the calculations (as shown below) to help learners see that each time there is a row of 9 added.

	1	2	3	4	5	6	7	8	9
1	●	●	●	●	●	●	●	●	●
2	●	●	●	●	●	●	●	●	●

	1	2	3	4	5	6	7	8	9
1	●	●	●	●	●	●	●	●	●
2	●	●	●	●	●	●	●	●	●
3	●	●	●	●	●	●	●	●	●

	1	2	3	4	5	6	7	8	9
1	●	●	●	●	●	●	●	●	●
2	●	●	●	●	●	●	●	●	●
3	●	●	●	●	●	●	●	●	●
4	●	●	●	●	●	●	●	●	●

- You can then help learners to understand that 9 is added each time by writing out the repeated addition sum for each diagram on the board:
 - $9 + 9$ is 18
 - $9 + 9 + 9$ is 27
 - $9 + 9 + 9 + 9$ is 36

Activity 2: Learners work in pairs

- Ask pairs of learners to use their array diagrams to find the answers to the following:
 - 5×9
 - 6×9
 - 7×9
 - 8×9

- 9×9
- Learners need to record the number sentences and answers in their classwork books.
- Ask: **How can we find the answer for each of them?** (By adding 9 to the previous answer.)
- Learners can then use these calculations and answers to create the rest of the 6 times table (up to 9×9).
- Draw this table on the board:
- Complete the table together as a class.

	1	(2)	3	4	5	6	7	8	(9)
$\times 9$	(9)	18	(27)	(36)	(45)	(54)	(63)	(72)	81

- Now draw this flow diagram on the board (you can make it go up to 9×9):
- Complete it together as a class explaining that this is another way in which you can write up the multiples of 9.

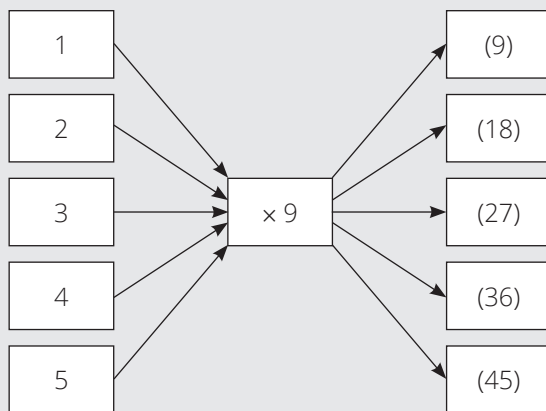

3 CLASSWORK ACTIVITY AND CORRECTION OF HOMEWORK (25 MINUTES)

NOTE: Give each learner, each pair or each group of learners a set of multiplication cards for the **9 times table**. Learners need to prepare these cards (cut them up and write the answers on the back) as they did for the multiplication cards of the other times tables. There are 4 activities suggested below – you can do all of them if you have enough time, otherwise select 2 or 3 activities to do in this lesson.

Rules of the game

- 1 Learners work in pairs.
 - a Learners shuffle the cards.
 - b One learner holds up a number sentence for the second learner to read.
 - c The second learner must read the number sentence and give the answer.
 - d The second learner then holds up a number sentence card for the first learner.
 - e Keep going until all the cards have been read.
- 2 Learners work in pairs.
 - a Learners shuffle the cards.

- b** Learners each hold up a number sentence card.
 - c** Learners need to say the answer to each other's cards.
 - d** Learners then each select another number sentence card to hold up.
- 3** Learners work in groups of 3.
- a** Learners shuffle the cards.
 - b** Learners lay out the cards with the answers facing up.
 - c** One learner calls out a multiplication number sentence.
 - d** The other 2 learners need to find the card with the answer to the multiplication number sentence.
 - e** The first learner to find the correct card gets to keep the card.
 - f** When there are no more cards, the game can be played again with a different learner calling out the multiplication number sentences.
- 4** Learners work in pairs.
- a** Learners shuffle the cards.
 - b** Learners lay out the cards with the answers facing up.
 - c** One learner selects a card.
 - d** The other learner must look at the answer and say the correct multiplication number sentence.
 - e** If the learner says the correct multiplication number sentence they can keep the card.
 - f** The second learner then selects a card for the first learner.

Play the multiplication card game. Your teacher will explain the rules.

4 HOMEWORK ACTIVITY (5 MINUTES)

Complete the table:

	Multiplication	Repeated addition	Answer
1	5×9	$9 + 9 + 9 + 9 + 9$	(45)
2	3×9	$(9 + 9 + 9)$	(27)
3	(7×9)	$9 + 9 + 9 + 9 + 9 + 9 + 9$	(63)
4	2×9	$(9 + 9)$	(18)
5	(9×9)	$9 + 9 + 9 + 9 + 9 + 9 + 9 + 9 + 9$	(81)

5 REFLECTION AND SUMMARY OF LESSON (5 MINUTES)

Call the whole class to attention and summarise the key concepts of the lesson.

Today we have learnt the 9 times table.

Lesson 12: The 8 and 9 times tables

Teacher's notes

This lesson is one of the fully planned lessons to be used to cover the Term 2 curriculum.

CAPS topics: 1.2 Count forwards and backwards; 1.14 Repeated addition leading to multiplication; 2.1 Geometric patterns.

Lesson Objective: Learn the structure of the 8 and 9 times tables by identifying patterns.

Lesson Vocabulary: Multiples, calculate, multiply, times, array, pattern.

Resources: Array diagram (see *Printable Resources*), enlarged array diagram (for use by the teacher), multiplication cards (see *Printable Resources*).

Date: _____ Week _____ Day _____

1 MENTAL MATHS (10 MINUTES)

	Calculate:	Answer			Answer
1	8×2	16	6	9×3	27
2	8×1	8	7	9×2	18
3	8×3	24	8	9×1	9
4	8×5	40	9	9×5	45
5	8×4	32	10	9×4	36

2 LESSON CONTENT - CONCEPT DEVELOPMENT (45 MINUTES)

In this lesson learners will use the array diagram as they continue to learn about the 8 and 9 times table and recognise the pattern of increasing by 8 and 9 each time. The learners will use multiplication cards to practise the 8 and 9 times table. This practice helps learners memorise the tables. The learners prepared the cards of the 8 and 9 times tables in the previous lessons. *You should also refer to the tracker for the summary of the problem solving approach used in this lesson.*

Today we are using the 8 and 9 times table to solve the problems in context.

Activity 1: Learners work in pairs

- Give the learners array diagrams to work with.
- Write the following problem on the chalkboard:
There are 6 whole pizzas.
Each pizza is cut into 8 pieces.
 How many pieces of pizza are there in total?
- *The word problem must be written on three lines as shown above to assist learners to identify the critical information/numbers needed to solve the problem.*

- Read the problem.
- Let the learners read the problem until they read it fluently.
- Underline the numbers (6 and 8).
- Underline the question (How many pieces of pizza are there in total?) with a wavy line.
- Let learners work out the answer using their array diagrams.
- Let learners present their ideas about how to solve the problem.
- Ask learner to write the number sentence:
 $6 \times 8 = 48$
- Read the number sentence together several times, making the connection between the numbers in the number sentence and the story of the word problem.
- Confirm that the answer is 48 pieces of pizza.

Activity 2: Learners work in pairs

- Give the learners array diagrams to work with.
- Write the following problem on the chalkboard:
**There are 7 bags
of 9 oranges each.**
How many oranges are there in total?
- Read the problem.
- Let the learners read the problem until they read it fluently.
- Underline the numbers (7 and 9).
- Underline the question (How many oranges are there in total?) with a wavy line.
- Let learners work out the answer using their array diagrams.
- Let learners present their ideas about how to solve the problem.
- Ask learners to write the number sentence:
 $7 \times 9 = 63$
- Read the number sentence together several times, making the connection between the numbers in the number sentence and the story of the word problem.
- Confirm that the answer is 63 oranges.

3 CLASSWORK ACTIVITY AND CORRECTION OF HOMEWORK (25 MINUTES)

1 Write the number sentences with answers:

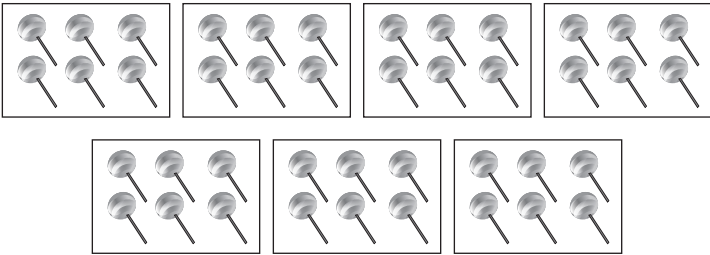
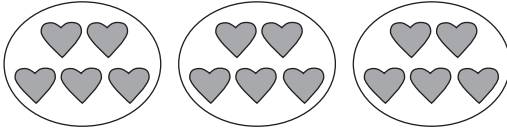
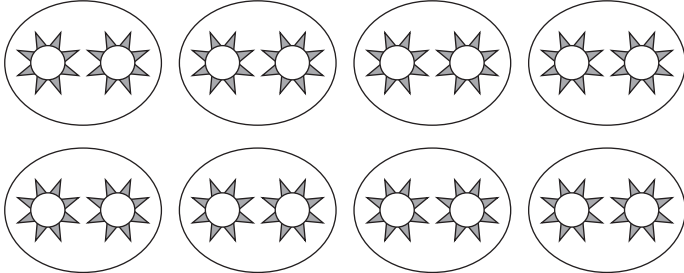
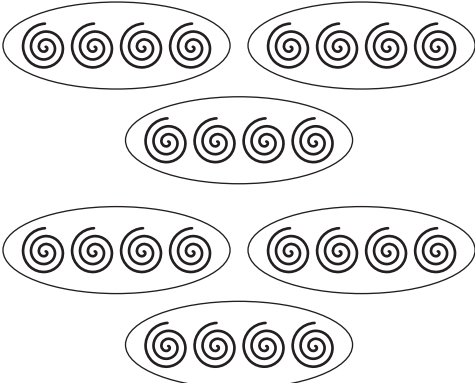
		Number sentence
a		$(4 \times 3 = 12)$
b		$(7 \times 6 = 42)$
c		$(3 \times 5 = 15)$
d		$(8 \times 2 = 16)$
e		$(6 \times 4 = 24)$

2 Write the number sentences with answers:

		Number sentence																																																		
a	<table border="1"> <tr> <td></td> <td>1</td> <td>2</td> <td>3</td> </tr> <tr> <td>1</td> <td>●</td> <td>●</td> <td>●</td> </tr> <tr> <td>2</td> <td>●</td> <td>●</td> <td>●</td> </tr> </table>		1	2	3	1	●	●	●	2	●	●	●	$(2 \times 3 = 6)$																																						
		1	2	3																																																
	1	●	●	●																																																
2	●	●	●																																																	
b	<table border="1"> <tr> <td></td> <td>1</td> <td>2</td> <td>3</td> <td>4</td> <td>5</td> </tr> <tr> <td>1</td> <td>●</td> <td>●</td> <td>●</td> <td>●</td> <td>●</td> </tr> <tr> <td>2</td> <td>●</td> <td>●</td> <td>●</td> <td>●</td> <td>●</td> </tr> <tr> <td>3</td> <td>●</td> <td>●</td> <td>●</td> <td>●</td> <td>●</td> </tr> <tr> <td>4</td> <td>●</td> <td>●</td> <td>●</td> <td>●</td> <td>●</td> </tr> <tr> <td>5</td> <td>●</td> <td>●</td> <td>●</td> <td>●</td> <td>●</td> </tr> <tr> <td>6</td> <td>●</td> <td>●</td> <td>●</td> <td>●</td> <td>●</td> </tr> <tr> <td>7</td> <td>●</td> <td>●</td> <td>●</td> <td>●</td> <td>●</td> </tr> </table>		1	2	3	4	5	1	●	●	●	●	●	2	●	●	●	●	●	3	●	●	●	●	●	4	●	●	●	●	●	5	●	●	●	●	●	6	●	●	●	●	●	7	●	●	●	●	●	$(7 \times 5 = 35)$		
		1	2	3	4	5																																														
	1	●	●	●	●	●																																														
	2	●	●	●	●	●																																														
	3	●	●	●	●	●																																														
	4	●	●	●	●	●																																														
	5	●	●	●	●	●																																														
6	●	●	●	●	●																																															
7	●	●	●	●	●																																															
c	<table border="1"> <tr> <td></td> <td>1</td> <td>2</td> </tr> <tr> <td>1</td> <td>●</td> <td>●</td> </tr> <tr> <td>2</td> <td>●</td> <td>●</td> </tr> <tr> <td>3</td> <td>●</td> <td>●</td> </tr> <tr> <td>4</td> <td>●</td> <td>●</td> </tr> <tr> <td>5</td> <td>●</td> <td>●</td> </tr> <tr> <td>6</td> <td>●</td> <td>●</td> </tr> <tr> <td>7</td> <td>●</td> <td>●</td> </tr> <tr> <td>8</td> <td>●</td> <td>●</td> </tr> <tr> <td>9</td> <td>●</td> <td>●</td> </tr> </table>		1	2	1	●	●	2	●	●	3	●	●	4	●	●	5	●	●	6	●	●	7	●	●	8	●	●	9	●	●	$(9 \times 2 = 18)$																				
		1	2																																																	
	1	●	●																																																	
	2	●	●																																																	
	3	●	●																																																	
	4	●	●																																																	
	5	●	●																																																	
	6	●	●																																																	
	7	●	●																																																	
8	●	●																																																		
9	●	●																																																		
d	<table border="1"> <tr> <td></td> <td>1</td> <td>2</td> <td>3</td> <td>4</td> <td>5</td> <td>6</td> <td>7</td> <td>8</td> <td>9</td> </tr> <tr> <td>1</td> <td>●</td> <td>●</td> <td>●</td> <td>●</td> <td>●</td> <td>●</td> <td>●</td> <td>●</td> <td>●</td> </tr> <tr> <td>2</td> <td>●</td> <td>●</td> <td>●</td> <td>●</td> <td>●</td> <td>●</td> <td>●</td> <td>●</td> <td>●</td> </tr> <tr> <td>3</td> <td>●</td> <td>●</td> <td>●</td> <td>●</td> <td>●</td> <td>●</td> <td>●</td> <td>●</td> <td>●</td> </tr> <tr> <td>4</td> <td>●</td> <td>●</td> <td>●</td> <td>●</td> <td>●</td> <td>●</td> <td>●</td> <td>●</td> <td>●</td> </tr> </table>		1	2	3	4	5	6	7	8	9	1	●	●	●	●	●	●	●	●	●	2	●	●	●	●	●	●	●	●	●	3	●	●	●	●	●	●	●	●	●	4	●	●	●	●	●	●	●	●	●	$(4 \times 9 = 36)$
		1	2	3	4	5	6	7	8	9																																										
	1	●	●	●	●	●	●	●	●	●																																										
	2	●	●	●	●	●	●	●	●	●																																										
3	●	●	●	●	●	●	●	●	●																																											
4	●	●	●	●	●	●	●	●	●																																											

WEEK 3

									Number sentence
e		1	2	3	4	5	6	7	$(8 \times 7 = 56)$
	1	●	●	●	●	●	●	●	
	2	●	●	●	●	●	●	●	
	3	●	●	●	●	●	●	●	
	4	●	●	●	●	●	●	●	
	5	●	●	●	●	●	●	●	
	6	●	●	●	●	●	●	●	
	7	●	●	●	●	●	●	●	
	8	●	●	●	●	●	●	●	

3 Write the number sentences with answers:

	Repeated addition	Number sentence
a	$4 + 4 + 4 + 4 =$	$(4 \times 4 = 16)$
b	$6 + 6 + 6 + 6 + 6 + 6 + 6 + 6 + 6 =$	$(9 \times 6 = 54)$
c	$8 + 8 + 8 + 8 + 8 =$	$(5 \times 8 = 40)$
d	$3 + 3 + 3 + 3 + 3 + 3 + 3 =$	$(7 \times 3 = 21)$
e	$5 + 5 + 5 + 5 + 5 =$	$(5 \times 5 = 25)$

4 HOMEWORK ACTIVITY (5 MINUTES)

Write the number sentences with answers:

	Repeated addition	Number sentence
a	$9 + 9 + 9 + 9 + 9 + 9 + 9 + 9 =$	$(8 \times 9 = 72)$
b	$2 + 2 + 2 + 2 + 2 + 2 + 2 =$	$(7 \times 2 = 14)$
c	$7 + 7 + 7 + 7 + 7 + 7 =$	$(6 \times 7 = 42)$
d	$6 + 6 =$	$(2 \times 6 = 12)$
e	$3 + 3 + 3 + 3 =$	$(4 \times 3 = 12)$

5 REFLECTION AND SUMMARY OF LESSON (5 MINUTES)

Call the whole class to attention and summarise the key concepts of the lesson.

Today we have learnt the 8 and 9 times tables, and have written number sentences.

Lesson 13: The 1 times table

Teacher's notes

This lesson is one of the fully planned lessons to be used to cover the Term 2 curriculum.

CAPS topics: 1.2 Count forwards and backwards; 1.14 Repeated addition leading to multiplication; 2.1 Geometric patterns.

Lesson Objective: Identify the rule of the 1 times table.

Lesson Vocabulary: Multiples, calculate, multiply, times, array, pattern.

Resources: Array diagram (see *Printable Resources*), enlarged array diagram (for use by the teacher), multiplication cards (see *Printable Resources*).

Date:

Week

Day

WEEK 3

1 MENTAL MATHS (10 MINUTES)

	Count forwards in:	Answer
1	2s up to 20	2, 4, 6, 8, 10, 12, 14, 16, 18, 20
2	3s up to 30	3, 6, 9, 12, 15, 18, 21, 24, 27, 30
3	4s up to 40	4, 8, 12, 16, 20, 24, 28, 32, 36, 40
4	5s up to 50	5, 10, 15, 20, 25, 30, 35, 40, 45, 50

2 LESSON CONTENT – CONCEPT DEVELOPMENT (45 MINUTES)

In this lesson learners will revise the times tables that they have learnt and identify the rule of the 1 times table. Learners will come to realise that any number multiplied by 1 stays the same. The learners will use multiplication cards to practise their times tables to memorise the tables.

Today we are learning the rule of the 1 times table.

Activity 1: Learners work in pairs

- Write the following problem on the board:
There are 5 bags of fruit.
Each bag contains 2 oranges
and 1 apple.
- *The word problem must be written on three lines as shown above to assist learners to identify the critical information/numbers needed to solve the problem.*
- Read the problem.
- Let the learners read the problem until they read it fluently.
- Underline the numbers that tell us about the fruit (5, 2, 1).

- Ask: **How many oranges are there in total?**
- Ask: **How many apples are there in total?**
- Ask learner to write the number sentence for both fruits.
 $5 \times 2 = 10$ oranges
 $5 \times 1 = 5$ apples
- Ask: **Why do both number sentences start with $5 \times$?** (This is a VERY important discussion. Because there are 5 bags of fruit, each with two different types of fruit.)
- Confirm that the answer is 10 oranges and 5 apples.

Activity 2: Whole class activity

- Give each pair of learners an array diagram.
- Ask: **How do we show $4 \times 1 =$ using an array?** (Allow learners time to think about this.)
- *Show the class the array diagrams (as shown below) which indicate how the answer to 4×1 can be shown using an array.*

	1
1	●

	1
1	●
2	●

	1
1	●
2	●
3	●

	1
1	●
2	●
3	●
4	●

- Ask: **What is 4×1 ?** (Learners could hold up their fingers to show the answer.)
- Ask: **What do you notice about the answer to 4×1 ?** (It's 4).
- Repeat with all the 1 times table number sentences (in a random order) up to 9×1 .
- Ask: **What do you notice about the answers to the 1 times table number sentences?** (The answer is the same as the number of groups).
- *Use this as an opportunity to see whether learners have identified the rule of the 1 times table.*

Activity 3: Learners work in pairs

Give each learner, each pair or each group of learners a set of multiplication cards for the **1 times table**. Learners should have prepared these cards in the previous lesson.

Rules of the game

- 1 Learners work in pairs.
 - a Learners shuffle the cards.
 - b Learners each hold up a number sentence card.
 - c Learners need to say the answer to each other's cards.
 - d Learners then each select another number sentence card to hold up.

- 2** Learners work in pairs.
- Learners shuffle the cards.
 - Learners lay out the cards with the answers facing up.
 - One learner selects a card.
 - The other learner must look at the answer and say the correct multiplication number sentence.
 - If the learner says the correct multiplication number sentence they can keep the card.
 - The second learner then selects a card for the first learner.

3 CLASSWORK ACTIVITY AND CORRECTION OF HOMEWORK (25 MINUTES)

- 1** Write the number sentences with answers:

		Number sentence
a	9 groups of 1	$(9 \times 1 = 9)$
b	7 groups of 4	$(7 \times 4 = 28)$
c	5 groups of 1	$(5 \times 1 = 5)$
d	6 groups of 3	$(6 \times 3 = 18)$
e	1 group of 1	$(1 \times 1 = 1)$

- 2** Calculate:

- | | |
|------------------------------|------------------------------|
| a $4 \times 1 = (4)$ | b $2 \times 8 = (16)$ |
| c $8 \times 1 = (8)$ | d $3 \times 7 = (21)$ |
| e $4 \times 6 = (24)$ | f $5 \times 8 = (40)$ |
| g $6 \times 7 = (42)$ | h $8 \times 8 = (64)$ |

- 3** Write the number sentences with answers:

	Repeated addition	Number sentence
a	$4 + 4 + 4 + 4 =$	$(4 \times 4 = 16)$
b	$6 + 6 + 6 + 6 + 6 + 6 + 6 + 6 =$	$(9 \times 6 = 54)$
c	$8 + 8 + 8 + 8 + 8 =$	$(5 \times 8 = 40)$
d	$3 + 3 + 3 + 3 + 3 + 3 + 3 =$	$(7 \times 3 = 21)$
e	$5 + 5 + 5 + 5 + 5 =$	$(5 \times 5 = 25)$

4 HOMEWORK ACTIVITY (5 MINUTES)

Write the number sentences with answers:

		Number sentence
a	3 groups of 1	$(3 \times 1 = 3)$
b	4 groups of 6	$(4 \times 6 = 24)$
c	8 groups of 1	$(8 \times 1 = 8)$
d	2 groups of 7	$(2 \times 7 = 14)$
e	5 groups of 1	$(5 \times 1 = 5)$

5 REFLECTION AND SUMMARY OF LESSON (5 MINUTES)

Call the whole class to attention and summarise the key concepts of the lesson.

Today we have learnt the rule for the 1 times table and revised the times tables up to 9.

Lesson 14: Doubling and repeated addition

Teacher's notes

This lesson is one of the fully planned lessons to be used to cover the Term 2 curriculum.

CAPS topics: 1.5 Place value.

Lesson Objective: Solve problems using doubling and repeated addition.

Lesson Vocabulary: Multiples, calculate, multiply, times, array, pattern, double, doubling.

Resources: n/a.

Date:

Week

Day

WEEK 3

1 MENTAL MATHS (10 MINUTES)

	Calculate:	Answer			Answer
1	2×3	6	6	2×6	12
2	2×1	2	7	2×8	16
3	2×4	8	8	2×9	18
4	2×2	4	9	2×7	14
5	2×5	10	10	2×10	20

2 LESSON CONTENT - CONCEPT DEVELOPMENT (45 MINUTES)

In this lesson learners will revise the concepts of doubling. Learners will realise that doubling is the same as multiplying by 2 and need to be able to verbalise these strategies. Repeated addition (finding multiples by adding, as we have done in all of the previous lessons when we generated the multiplication tables by adding) is also used. Note that it is more efficient for learners to know their multiplication tables by heart than to find them by adding. They then work with multiples rather than by doing addition. This prepares them for doing division. *You should also refer to the tracker for the summary of the problem solving approach used in this lesson.*

Today we are learning to solve problems using doubling and repeated addition.

Activity 1: Learners work in pairs

- Call out a number sentence to the class, without giving the answer:
- $2 \times 10 = ?$
- Ask learners solve the problem as quickly as possible and tell their partner the answer.
- *Allow learners to write in their classwork books if they need to work out the answer, however the goal is for learners to be able to solve these problems mentally by doubling or saying two tens is 20.*

- Ask: **How did you solve this problem?** (2 groups of 10, I doubled 10.)
- *Take some time to discuss the fact that $10 + 10$ is the same as 2×10 .*
- Repeat with different problems involving doubles of the multiples of 5 up to 50. (i.e. $2 \times$ (multiples of 5 up to 50)):
- Ask the learners to calculate the following:
 - 2×20
 - 2×15
 - 2×5
 - 2×30
 - 2×25
 - 2×40
 - 2×35
 - 2×50
 - 2×45

Activity 2: Whole class activity

- Write the following problem on the board:
On one day at the clinic 45 learners were given flu vaccinations.
The next day 46 learners were vaccinated.
 How many learners were vaccinated altogether?
- *The word problem must be written on three lines as shown above to assist learners to identify the critical information/numbers needed to solve the problem.*
- Read the problem.
- Let the learners read the problem until they read it fluently.
- Underline the numbers (45, 46).
- Underline the question (How many learners were vaccinated altogether?) with a wavy line.
- Let learners work out the answer. ($45 + 46 =$)
- Let learners present their ideas about how to solve the problem.
- *The focus here is on getting learners to see that they can solve the problem through doubling. Observe learners as they solve the problem, and select different learners to present their solutions. Ensure that at least one of the selected learners solved the problem by doubling. If you can't identify any learners solving the problem through doubling, then you will need to model doubling as a strategy yourself.*
- Ask a learner to show their solution on the board:
 - $45 + 45 + 1 = 91$
 - $2 \times 45 = 90$
 - $90 + 1 = 91$ learners were vaccinated
- Another way of finding the answer to this problem through doubling may be:
 - $46 + 46 - 1 = 91$
 - $2 \times 46 = 92$
 - $92 - 1 = 91$ learners were vaccinated

- Confirm that the answer is 91 learners.

Activity 3: Whole class activity

- Draw the following table on the board:

	1	2	3	4	5	6	7	8	9
× 5									
× 10									

- Ask learners to come up to the board to complete the answers to the × 5 row and then the × 10 row. (Call up many different learners to help complete the table so that the whole class participates in the activity.)

	1	2	3	4	5	6	7	8	9
× 5	5	10	15	20	25	30	35	40	45
× 10	10	20	30	40	50	60	70	80	90

- Ask: **What do you notice about the numbers we filled in for the × 5 and the × 10 rows?** (Discuss all the observations. They all end in 5 or 0, the numbers get bigger by 5 (or 10) each time, they are the same numbers we say when we count in 5s (or 10s)).
- Point to a number in the table, for example 30 in the × 5 row.
- Ask: **What repeated addition number sentence shows how we get 30?** ($5 + 5 + 5 + 5 + 5 + 5 = 30$)
- Ask: **What do you notice about the number of times we added 5?** (We added 5 six times, the number in the top row is the same as the number of times we add 5, $5 + 5 + 5 + 5 + 5 + 5$ is the same as 6×5).
- Point to the number 70 in the × 10 row.
Ask: **What repeated addition number sentence shows how we get 70?** ($10 + 10 + 10 + 10 + 10 + 10 + 10 = 70$)
- Ask: **What do you notice about the number of times we added 10?** (We added 10 seven times, the number in the top row is the same as the number of times we add 10, $10 + 10 + 10 + 10 + 10 + 10 + 10$ is the same as 7×10).
- Do this for other numbers in the table if there is time.

3 CLASSWORK ACTIVITY AND CORRECTION OF HOMEWORK (25 MINUTES)

- 1 Calculate by doubling:

	Multiple	Double	Answer
a	2×50	$50 + 50 =$	(100)
b	2×15	$(15 + 15 =)$	(30)
c	2×35	$(35 + 35 =)$	(70)
d	2×10	$(10 + 10 =)$	(20)

	Multiple	Double	Answer
e	2×45	$(45 + 45 =)$	(90)
f	2×25	$(25 + 25 =)$	(50)
g	2×30	$(30 + 30 =)$	(60)
h	2×40	$(40 + 40 =)$	(80)

2 Calculate by doubling:

	Multiple	Double	Add	Answer
a	2×51	$50 + 1 + 50 + 1$	$100 + 2$	(102)
b	2×46	$(45 + 1 + 45 + 1)$	$(90 + 2)$	(92)
c	2×31	$(30 + 1 + 30 + 1)$	$(60 + 2)$	(62)
d	2×16	$(15 + 1 + 15 + 1)$	$(30 + 2)$	(32)
e	2×17	$(15 + 2 + 15 + 2)$	$(30 + 4)$	(34)
f	2×26	$(25 + 1 + 25 + 1)$	$(50 + 2)$	(52)
g	2×41	$(40 + 1 + 40 + 1)$	$(80 + 2)$	(82)
h	2×36	$(35 + 1 + 35 + 1)$	$(70 + 2)$	(72)

3 Bongwiwe had 20 balloons.
 Her mom gave her 21 balloons.
 How many balloons did she have altogether?
 $(20 + 21 = 20 + 20 + 1 = 40 + 1 = 41)$
 (41 balloons altogether)

4 Nomsa had a bunch of 35 flowers.
 She was given another bunch of 36 flowers.
 How many flowers did she have altogether?
 $(35 + 36 = 35 + 35 + 1 = 70 + 1 = 71)$
 (71 flowers altogether)

4 HOMEWORK ACTIVITY (5 MINUTES)

Nelisiwe has 41 pieces of string.
 She cuts another 41 pieces of string.
 How many pieces of string does she have now?
 $(2 \times 41 = 40 + 1 + 40 + 1 = 80 + 2 = 82)$
 (82 pieces of string)

5 REFLECTION AND SUMMARY OF LESSON (5 MINUTES)

Call the whole class to attention and summarise the key concepts of the lesson.
 Today we have learnt to solve problems using doubling and repeated addition.

Lesson 15: Consolidation

Teacher's notes

This lesson allows for consolidation of the previous days' lesson content.

CAPS topics: 1.2 Count forwards and backwards; 1.5 Place value; 1.14 Repeated addition leading to multiplication; 2.1 Geometric patterns.

Lesson Objective: Revise multiplication, repeated addition and doubling.

Lesson Vocabulary: Multiples, calculate, multiply, times, array, pattern.

Resources: n/a.

Date:

Week

Day

WEEK 3

1 NOTES FOR THE TEACHER RELATING TO THIS WEEK'S WORK

This week learners have continued to focus on multiplication. Learners have identified rules and patterns, and have used doubling and repeated addition as strategies to solve problems.

2 POSSIBLE MISCONCEPTIONS LINKED TO THE WEEK'S WORK

It is important for learners to know the times tables well so that they can solve problems easily and quickly. Learners need many opportunities to practise the tables. Make sure that learners understand that a multiplication number sentence such as 5×7 means that there are 5 groups of 7.

3 CLASSWORK/HOMEWORK – COMPLETE THIS WEEK'S CLASSWORK AS NEEDED

Today we are going over what we learned this week. We are learning more about multiplication.

4 ADDITIONAL ACTIVITIES FOR CONSOLIDATION – SEE LEARNER RESOURCES

1 Write the number sentences with answers:

		Number sentence
a.		$(7 \times 6 = 42)$

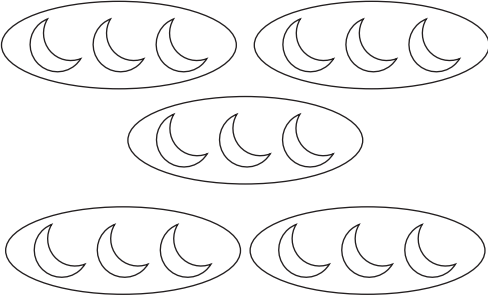
		Number sentence																																													
b.		$(5 \times 3 = 15)$																																													
c.	<table border="1" data-bbox="395 705 735 1086"> <tr> <td></td> <td>1</td> <td>2</td> <td>3</td> <td>4</td> </tr> <tr> <td>1</td> <td>●</td> <td>●</td> <td>●</td> <td>●</td> </tr> <tr> <td>2</td> <td>●</td> <td>●</td> <td>●</td> <td>●</td> </tr> <tr> <td>3</td> <td>●</td> <td>●</td> <td>●</td> <td>●</td> </tr> <tr> <td>4</td> <td>●</td> <td>●</td> <td>●</td> <td>●</td> </tr> <tr> <td>5</td> <td>●</td> <td>●</td> <td>●</td> <td>●</td> </tr> <tr> <td>6</td> <td>●</td> <td>●</td> <td>●</td> <td>●</td> </tr> </table>		1	2	3	4	1	●	●	●	●	2	●	●	●	●	3	●	●	●	●	4	●	●	●	●	5	●	●	●	●	6	●	●	●	●	$(6 \times 4 = 24)$										
	1	2	3	4																																											
1	●	●	●	●																																											
2	●	●	●	●																																											
3	●	●	●	●																																											
4	●	●	●	●																																											
5	●	●	●	●																																											
6	●	●	●	●																																											
d.	<table border="1" data-bbox="395 1117 1003 1389"> <tr> <td></td> <td>1</td> <td>2</td> <td>3</td> <td>4</td> <td>5</td> <td>6</td> <td>7</td> <td>8</td> </tr> <tr> <td>1</td> <td>●</td> <td>●</td> <td>●</td> <td>●</td> <td>●</td> <td>●</td> <td>●</td> <td>●</td> </tr> <tr> <td>2</td> <td>●</td> <td>●</td> <td>●</td> <td>●</td> <td>●</td> <td>●</td> <td>●</td> <td>●</td> </tr> <tr> <td>3</td> <td>●</td> <td>●</td> <td>●</td> <td>●</td> <td>●</td> <td>●</td> <td>●</td> <td>●</td> </tr> <tr> <td>4</td> <td>●</td> <td>●</td> <td>●</td> <td>●</td> <td>●</td> <td>●</td> <td>●</td> <td>●</td> </tr> </table>		1	2	3	4	5	6	7	8	1	●	●	●	●	●	●	●	●	2	●	●	●	●	●	●	●	●	3	●	●	●	●	●	●	●	●	4	●	●	●	●	●	●	●	●	$(4 \times 8 = 32)$
	1	2	3	4	5	6	7	8																																							
1	●	●	●	●	●	●	●	●																																							
2	●	●	●	●	●	●	●	●																																							
3	●	●	●	●	●	●	●	●																																							
4	●	●	●	●	●	●	●	●																																							

2 Write the number sentences with answers:

	Repeated addition	Number sentence
a	$2 + 2 + 2 + 2 + 2 + 2 + 2 + 2 + 2 =$	$(9 \times 2 = 18)$
b	$5 + 5 + 5 + 5 =$	$(4 \times 5 = 20)$
c	$7 + 7 + 7 + 7 + 7 + 7 + 7 =$	$(7 \times 7 = 49)$
d	$4 + 4 + 4 + 4 + 4 =$	$(5 \times 4 = 20)$
e	$6 + 6 + 6 + 6 + 6 + 6 + 6 + 6 =$	$(8 \times 6 = 48)$

3 Write the number sentences with answers:

		Number sentence
a	3 groups of 4	$(3 \times 4 = 12)$
b	4 groups of 8	$(4 \times 8 = 32)$
c	9 groups of 9	$(9 \times 9 = 81)$
d	2 groups of 5	$(2 \times 5 = 10)$
e	6 groups of 7	$(6 \times 7 = 42)$

4 Calculate by doubling:

	Multiple	Double	Add	Answer
a	2×16	$15 + 1 + 15 + 1$	$30 + 2$	(32)
b	2×41	$(40 + 1 + 40 + 1)$	$(80 + 2)$	(82)
c	2×26	$(25 + 1 + 25 + 1)$	$(50 + 2)$	(52)
d	2×52	$(50 + 2 + 50 + 2)$	$(100 + 4)$	(104)
e	2×38	$(35 + 3 + 35 + 3)$	$(70 + 6)$	(76)

5 REFLECTION AND SUMMARY OF LESSON

Call the whole class to attention and summarise the key concepts of the lesson.

Today we have learnt to multiply and solve problems by using doubling and repeated addition.

Week 4

Lesson 16: Assessment

Teacher's notes		
This lesson should be used for assessment of the content covered in this unit to date.		
CAPS topics: 1.2 Count forwards and backwards; 1.5 Place value; 1.14 Repeated addition leading to multiplication; 2.1 Geometric patterns.		
Resources: Printable assessment in teacher's resources.		
Date:	Week	Day

1 SETTLE THE CLASS AND ADMINISTER THE ASSESSMENT. (45 MINUTES)

The assessment for today is linked to the work covered in the unit to date.

You will find the printable version of the assessment in the teacher's resource pack.

2 DISCUSS ASSESSMENT ITEMS WITH THE CLASS (45 MINUTES)

Take in the learners' work when they are done.

There should be time for you to discuss a few of the items with the class:

- use this opportunity to reflect on different methods used by learners (allow some learners to write their solutions on the board).
- speak about misconceptions that may have arisen in learners' responses.

3 ASSESSMENT

WRITTEN ASSESSMENT (20)

- 1 Write the number sentences with answers: (5)

											Number sentence
a		1	2	3	4	5	6	7	8	9	$(3 \times 9 = 27)$
	1	●	●	●	●	●	●	●	●	●	
	2	●	●	●	●	●	●	●	●	●	
	3	●	●	●	●	●	●	●	●	●	

b		1	2	3	4	5	6	$(5 \times 6 = 30)$
	1	●	●	●	●	●	●	
	2	●	●	●	●	●	●	
	3	●	●	●	●	●	●	
	4	●	●	●	●	●	●	
	5	●	●	●	●	●	●	
c	7 groups of 2							$(7 \times 2 = 14)$
d	3 groups of 8							$(3 \times 8 = 24)$
e	6 groups of 5							$(6 \times 5 = 30)$

2 Write the number sentences with answers: (4)

	Repeated addition	Number sentence
a	$7 + 7 + 7 + 7 + 7 + 7 + 7 + 7 =$	$(8 \times 7 = 56)$
b	$3 + 3 + 3 + 3 + 3 =$	$(5 \times 3 = 15)$
c	$9 + 9 + 9 + 9 + 9 + 9 =$	$(6 \times 9 = 54)$
d	$5 + 5 + 5 + 5 + 5 + 5 + 5 + 5 + 5 =$	$(9 \times 5 = 45)$

3 Calculate by doubling: (5)

	Multiple	Double	Add	Answer
a	2×21	$20 + 1 + 20 + 1$	$40 + 2$	(42)
b	2×36	$(35 + 1 + 35 + 1)$	$(70 + 2)$	(72)
c	2×47	$(45 + 2 + 45 + 2)$	$(90 + 4)$	(94)

4 Solve the problems. (2 × 3 = 6)

a Silindile has 21 shells. She finds another 21 shells. How many shells does she have now?

$$2 \times 21 = 20 + 1 + 20 + 1 = 40 + 2 = 42$$

42 shells

b Lindo has 45 marbles. He wins another 46 marbles. How many marbles does he have now?

$$45 + 46 = 45 + 45 + 1 = 90 + 1 = 91$$

91 marbles

Unit 2 Introduction

In this unit you will be able to focus on the four framework dimensions in the following way:

- **Conceptual understanding:** In this unit learners develop their conceptual understanding through practicing procedures and verbalising their thoughts, strategies and solutions. As learners verbalise, they are able to further develop their own understanding.
- **Procedural fluency:** Learners work with problems that are presented in similar ways so that they can become more confident in using the various solution strategies. This should increase their ability to solve problems more fluently, that is, quickly and easily.
- **Strategies:** Learners need to understand and develop strategies to solve problems. Learners should be encouraged to verbalise their solutions to problems so that they can see other ways of finding answers. In this unit learners will develop their understanding of the commutative and distributive laws of multiplication which will enable them to work with multiplication more flexibly.
- **Reasoning:** Learners are encouraged to talk about their understanding of concepts and solutions, and to provide explanations and reasons for the methods they use to find solutions.

Building a **learning centred classroom** in this unit will involve (amongst other things) attention to:

- **Addressing learners' errors:** In this unit there are a number of consolidation and assessment opportunities that will make it possible to identify and address learners' errors. There are clear links between lessons which enable learners to build upon their knowledge and to correct misunderstandings they may have formed.
- **Practising procedures:** Learners are given multiple opportunities to practise solving problems in similar ways in order to develop their procedural fluency. This also helps learners to make connections between concepts and strategies.
- **Connecting representations:** In this unit, learners use arrays, multiplication tables, number symbols and operation symbols when they do and record their work. The lessons are designed to help them make connections between these representations in order to deepen their conceptual understanding of multiplication.
- **Explaining concepts and procedures:** Learners are required to discuss their thoughts and methods of solution with their peers. This is an important way of extending and deepening their conceptual understanding.

Lesson 17: Multiplication patterns

Teacher's notes

This lesson is one of the fully planned lessons to be used to cover the Term 2 curriculum.

CAPS topics: 1.2 Count forwards and backwards; 1.14 Repeated addition leading to multiplication.

Lesson Objective: Develop an understanding of the commutative law of multiplication.

Lesson Vocabulary: Multiplies, calculate, multiply, times, array, pattern.

Resources: Array diagram (see *Printable Resources*), multiplication table (see *Printable Resources*), enlarged array diagram and multiplication table (for use by the teacher), multiplication cards (see *Printable Resources*).

Date:

Week

Day

1 MENTAL MATHS (10 MINUTES)

	What is ...	Answer		What is ...	Answer
1	5×4	20	6	2×7	14
2	4×5	20	7	8×5	40
3	6×3	18	8	5×8	40
4	3×6	18	9	9×3	27
5	7×2	14	10	3×9	27

2 LESSON CONTENT - CONCEPT DEVELOPMENT (45 MINUTES)

In today's lesson learners will continue to investigate patterns in multiplication. The focus in this lesson is on the commutative law of multiplication. Learners do not need to learn the name of the law but they need to learn that multiplication is commutative (the factors in a multiplication sentence are reversible, e.g. $5 \times 4 = 4 \times 5$). Ensure that learners are given opportunities to experience (for example) 5×4 as being equal to 4×5 .

Today we are learning about the commutative law of multiplication.

Activity 1: Learners work in pairs

- Give a multiplication table to each learner. Also, paste a big multiplication table on the board.
- Ask: **What do you notice in the table?**
- There may be many different answers, e.g.:
 - The number increases by 3 in the 3 times table;
 - 4×5 and 5×4 have the same answer;
 - There are four pairs who have the answer 12; or
 - If you add the 2 times table and 3 times table, it becomes the 5 times table.

- Check if the statement is correct or not – engage with as many as possible in a meaningful and encouraging way.
- *Learners should present their findings freely. Encourage them to find patterns in their discoveries.*

Activity 2: Learners work in pairs

- Give each learner an array diagram.
- Make pairs and let one learner show 5×3 using his/her array diagram.

	1	2	3
1	●	●	●
2	●	●	●
3	●	●	●
4	●	●	●
5	●	●	●

- Ask: **How many groups of dots are there?** (5 groups of 3 dots.)
- Let the other learner (in the pair) show 3×5 using his/her array diagram.

	1	2	3	4	5
1	●	●	●	●	●
2	●	●	●	●	●
3	●	●	●	●	●

- Ask: **How many groups of dots are there?** (3 groups of 5 dots.)
- Ask: **What do you notice about the total number of dots in the two array diagrams?** (They both have 15 dots.)
- Ask: **Why do 5×3 and 3×5 have the same number of dots?** (If we rotate the array diagram, it becomes the same arrangement.)
- Ask: **What can we say about the number sentence from this activity?** (When we calculate 3×5 and 5×5 , the answers are the same).
- Ask learners to use array diagrams for the following problems to find if they have the same answer:
 - 2×4 and 4×2
 - 3×7 and 7×3

Activity 3: Learners work in pairs

- Give each pair of learners a multiplication table.
- Say: **Use the multiplication table to find the answer to 6×4 .** (24)

	1	2	3	4	5	6	7	8	9	10
1	1	2	3	4	5	6	7	8	9	10
2	2	4	6	8	10	12	14	16	18	20
3	3	6	9	12	15	18	21	24	27	30
4	4	8	12	16	20	24	28	32	36	40
5	5	10	15	20	25	30	35	40	45	50
6	6	12	18	24	30	36	42	48	56	60
7	7	14	21	28	35	42	49	56	63	70
8	8	16	24	32	40	48	56	64	72	80
9	9	18	27	36	45	54	63	72	81	90
10	10	20	30	40	50	60	70	80	90	100

- Say: **Now see if you can find a different number sentence to make 35.** (Learners use their multiplication table to find $7 \times 5 = 35$)
- Say: **Write both number sentences with answers in your classwork book.**
- Ask: **What do you notice about the number sentences?** (They have the same numbers but in a different order).
- Repeat the above steps with the following: 3×9 , 4×8 , 9×6 and 6×7 .

3 CLASSWORK ACTIVITY AND CORRECTION OF HOMEWORK (25 MINUTES)

NOTE: Give each learner, each pair or each group of learners a set of multiplication cards of the 1-9 times table with the answers written at the back (these should have been prepared for previous lessons) In this lesson ask the learners to do one group activity and activity 4. They must do activity 4 as it consolidates teaching on the commutative law.

Rules of the game

- Learners work alone.
 - Learners shuffle the cards.
 - Learners take a number sentence card.
 - Learners need to say the answer to the number sentence shown on each card to themselves.
 - Learners check the answers by looking at the back of the card.
- Learners work in pairs.
 - Learners shuffle the cards.
 - One learner holds up a number sentence for the second learner to read.
 - The second learner must read the number sentence and give the answer.
 - Learners check the answers by looking at the back of the card.
 - The second learner then holds up a number sentence card for the first learner.

- f** Keep going until all the cards have been read.
- 3** Learners work in groups of 3.
 - a** Learners shuffle the cards.
 - b** Learners lay out the cards with the answers facing up.
 - c** One learner calls out a multiple – any one of the 1 to 9 times tables.
 - d** The other 2 learners need to find the card with the answer to the multiplication number sentence.
 - e** The first learner to find the card gets to keep the card. The learner who has the most cards at the end wins.
 - f** When there are no more cards, the game can be played again with a different learner calling out the multiplication questions.
- 4** Learners work alone.
 - a** Learners shuffle the cards.
 - b** Learners lay out the cards with the answers facing up.
 - c** Learners give a number sentence for which the answer is shown.
 - d** Learners check the answers by looking at the back of the card. (Note that they might find the factors written in the in reverse to what they have said because of the commutative law.)

Play the multiplication card game. Your teacher will explain the rules.

4 HOMEWORK ACTIVITY (5 MINUTES)

1 Draw circles in an array to show the multiple:

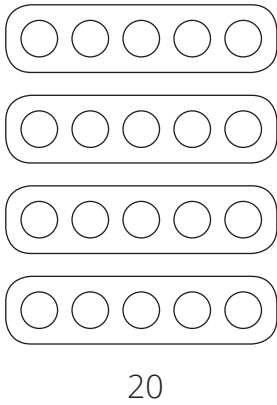
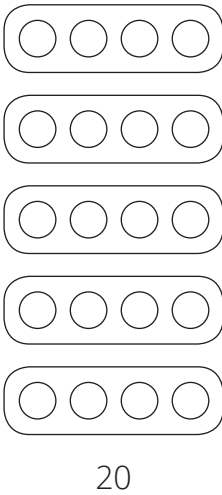
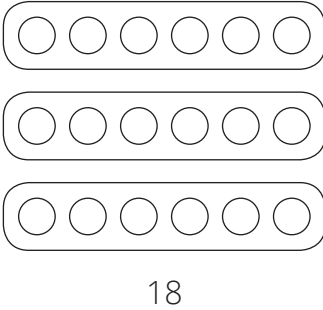
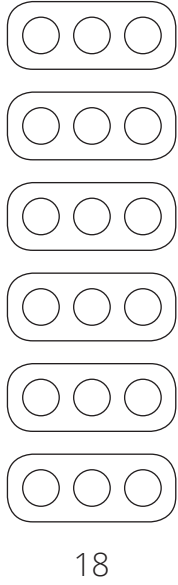
	Multiple	Array		Multiple	Array
a	4×5	 20	b	5×4	 20
c	3×6	 18	d	6×3	 18

5 REFLECTION AND SUMMARY OF LESSON (5 MINUTES)

Call the whole class to attention and summarise the key concepts of the lesson.

Today we have learnt about the commutative law of multiplication.

Lesson 18: Patterns in multiplication tables

Teacher's notes

This lesson is one of the fully planned lessons to be used to cover the Term 2 curriculum.

CAPS topics: 1.2 Count forwards and backwards; 1.14 Repeated addition leading to multiplication.

Lesson Objective: Consolidate understanding of the patterns (rules) in multiplication.

Lesson Vocabulary: Multiples, calculate, multiply, times, array, pattern.

Resources: Multiplication table (see *Printable Resources*), enlarged multiplication table (for use by the teacher), bottle tops, multiplication cards (see *Printable Resources*).

Date:

Week

Day

1 MENTAL MATHS (10 MINUTES)

	What is ...	Answer		What is ...	Answer
1	6×6	36	6	9×8	72
2	7×7	49	7	6×9	54
3	8×7	56	8	8×6	48
4	7×6	42	9	7×9	63
5	8×8	64	10	9×9	81

2 LESSON CONTENT - CONCEPT DEVELOPMENT (45 MINUTES)

In today's lesson learners will focus on the pattern that emerges when working with the multiplication table. Learners will begin to see the relationship between the multiplier (the number of groups) and the product (the answer). They will realise that as the multiplier is increased (repeated addition) then the product increases by the same amount.

Today we are learning about patterns (rules) in multiplication.

Activity 1: Whole class activity

- Place an enlarged multiplication table on the board.
- Cover the answer to 5×7 as shown below:

	1	2	3	4	5	6	7	8	9	10
1	1	2	3	4	5	6	7	8	9	10
2	2	4	6	8	10	12	14	16	18	20
3	3	6	9	12	15	18	21	24	27	30
4	4	8	12	16	20	24	28	32	36	40
5	5	10	15	20	25	30		40	45	50
6	6	12	18	24	30	36	42	48	56	60
7	7	14	21	28	35	42	49	56	63	70
8	8	16	24	32	40	48	56	64	72	80
9	9	18	27	36	45	54	63	72	81	90
10	10	20	30	40	50	60	70	80	90	100

- Ask: **What is the multiplication number sentence for the hidden number?** ($5 \times 7 = ?$)
- Ask: **How did you know that?** (Because the block that is covered in the table is in the 5th row and the 7th column – so it must show 5×7)
- Ask: **How do you think we can work out the answer to 5×7 ?** (Let learners discuss ways they could find the answer. Allow learners to suggest ideas to the class.)
- There may be many different answers, e.g.:
 - The numbers in the 5th row increase by 5 (or 5 is added each time as you go across the 5th row), so it must be $30 + 5 = 35$;
 - The numbers in the 7th column increase by 7 (or 7 is added each time as you go down the 7th column), so it must be $28 + 7 = 35$;
 - It is 5×7 , which I know is 35.

Activity 2: Learners work in pairs

- Give a multiplication table and some bottle tops to pairs of learners.
- Ask one learner to cover a number on the multiplication table with a bottle top.
- The other learner can identify the number sentence for the block and work out the answer.
- Encourage learners to discuss how they solved the problems.

3 CLASSWORK ACTIVITY AND CORRECTION OF HOMEWORK (25 MINUTES)

NOTE: Give each learner, each pair or each group of learners a set of multiplication cards for the **1-9 times tables**. Learners should have prepared these cards in the previous lessons. There are 4 activities suggested below – select at least 2 activities to do in this lesson. Learners will have more cards to play with if they use all of the 1-9 times table cards when they play the games in this lesson.





Rules of the game





- 1 Learners work alone.
 - a Learners shuffle the cards.
 - b Learners take a number sentence card.
 - c Learners need to say the answer to the number sentence shown on each card to themselves.
 - d Learners check the answers by looking at the back of the card.
- 2 Learners work in pairs.
 - a Learners shuffle the cards.
 - b One learner holds up a number sentence for the second learner to read.
 - c The second learner must read the number sentence and give the answer.
 - d The second learner then holds up a number sentence card for the first learner.
 - e Keep going until all the cards have been read.
- 3 Learners work in groups of 3.
 - a Learners shuffle the cards.
 - b Learners lay out the cards with the answers facing up.
 - c One learner calls out a multiplication number sentence.
 - d The other 2 learners need to find the card with the answer to the multiplication number sentence.
 - e The first learner to find the correct card gets to keep the card. The learner who gets the most cards wins.
 - f When there are no more cards, the game can be played again with a different learner calling out the multiplication number sentences.
- 4 Learners work alone.
 - a Learners shuffle the cards.
 - b Learners lay out the cards with the answers facing up.
 - c Learners give a number sentence for which the answer is shown.
 - d Learners check the answers by looking at the back of the card. (Note that they might find the factors written in the in reverse to what they have said because of the commutative law.)

Play the multiplication card game. Your teacher will explain the rules.

4 HOMEWORK ACTIVITY (5 MINUTES)

Write the number sentences for each of the covered numbers:

	1	2	3	4	5	6	7	8	9	10
1	1	2	3	4	5	6	7	8	9	10
2	2	4	6	8	10	12	14	16	18	20
3	3	6		12	15	18	21	24	27	30
4	4	8	12	16		24	28	32	36	40
5	5	10	15	20	25	30	35		45	50
6	6	12	18	24	30	36	42	48	56	60
7	7	14	21	28	35		49	56	63	70
8	8	16	24	32	40	48	56	64	72	80
9	9		27	36	45	54	63	72	81	90
10	10	20	30	40	50	60	70	80	90	100

- a  ($3 \times 3 = 9$)
- b  ($4 \times 5 = 20$)
- c  ($5 \times 8 = 40$)
- d  ($7 \times 6 = 42$)
- e  ($9 \times 2 = 18$)

5 REFLECTION AND SUMMARY OF LESSON (5 MINUTES)

Call the whole class to attention and summarise the key concepts of the lesson.

Today we have learnt to identify patterns (rules) in multiplication number sentences.

Lesson 19: Multiply by 10

Teacher's notes

This lesson is one of the fully planned lessons to be used to cover the Term 2 curriculum.

CAPS topics: 1.2 Count forwards and backwards; 1.14 Repeated addition leading to multiplication.

Lesson Objective: Develop an understanding of the patterns (rules) associated with multiplying by 10.

Lesson Vocabulary: Multiples, calculate, multiply, times, array, pattern.

Resources: n/a

Date:

Week

Day

1 MENTAL MATHS (10 MINUTES)

Count forwards in 10s up to 100 and backwards in 10s from 100 to 10.

2 LESSON CONTENT - CONCEPT DEVELOPMENT (45 MINUTES)

In today's lesson learners will continue to investigate patterns in multiplication. The focus in this lesson is on multiplying by 10. Ensure that learners are exposed to 10 as the multiplier (the number of groups) as well as the multiplicand (the number in one group).

Today we are learning about patterns (rules) when multiplying by 10.

Activity 1: Whole class activity

- Draw the following table on the board.
- *In today's lesson we will only focus on the second and third scores (i.e. the rows containing the number 10). The first and fourth rows (the rows containing the zero) will be dealt with in lesson 22.*

Score	Darts	Total
	0	0
4	10	40
10	3	30
0	7	0

- Tell learners that Sipho played a darts game and that he got the results shown in the table above.
- Ask: **What's the total score for 10 darts with a score of 4 for each dart?** (Encourage the learners to discuss how they could work out how many points were scored in total. 10 groups of 4 is 40; $4 + 4 + 4 + 4 + 4 + 4 + 4 + 4 + 4 + 4 = 40$; 9×4 is 36 which means if we add 4 more we have the score $10 \times 4 = 40$)

- Note that in this problem the 10 is the number of darts, $10 \times 4 = 40$.
- Ask: **What's the total score for 3 darts with a score of 10 for each dart?** (Discuss again. 3 groups of 10 is 30; $10 + 10 + 10 = 30$; $3 \times 10 = 30$)
- Note that in this problem the 10 is the score per dart, $3 \times 10 = 30$.

Activity 2: Learners work in groups

- Let learners work in groups of 3.
- One learner in the group can call out any number from 1 – 9.
- The other two learners then need to quickly give a number sentence in which they multiply that number by 10 and say two ways you could write a number sentence for that.
- For example:
Learner 1 calls out 6.
Learners 2 and 3 quickly give number sentences and their answers
 - $10 \times 6 = 60$
 - $6 \times 10 = 60$
- Note that learners could do this orally, or they could write the number sentences with answers in their classwork books.
- The first learner to say their number sentence and answer correctly gets to be the learner who chooses the next number to call out.
- This way the learners will take turns calling out the numbers and coming up with number sentences and answers which include the number 10.

3 CLASSWORK ACTIVITY AND CORRECTION OF HOMEWORK (25 MINUTES)

1 Complete the table:

		Repeated addition	Number sentence
a	5 groups of 2	$(2 + 2 + 2 + 2 + 2)$	$(5 \times 2 = 10)$
b	3 groups of 9	$(9 + 9 + 9)$	$(3 \times 9 = 27)$
c	(6 groups of 6)	$6 + 6 + 6 + 6 + 6 + 6$	$(6 \times 6 = 36)$
d	1 group of 10	(10)	$(1 \times 10 = 10)$
e	8 groups of 4	$4 + 4 + 4 + 4 + 4 + 4 + 4 + 4$	$(8 \times 4 = 32)$
f	(4 groups of 5)	$5 + 5 + 5 + 5$	$(4 \times 5 = 20)$
g	(7 groups of 10)	$10 + 10 + 10 + 10 + 10 + 10 + 10$	$(7 \times 10 = 70)$
h	5 groups of 7	$(7 + 7 + 7 + 7 + 7)$	$(5 \times 7 = 35)$

2 Solve the problems:

- a** I have 3 R10 bank notes. How much money do I have altogether?
($3 \times 10 = 30$; R30 in total)

- b** I have 7 R10 notes. How much money do I have altogether?
 ($7 \times 10 = 70$; R70 in total)

4 HOMEWORK ACTIVITY (5 MINUTES)

Complete the table:

		Repeated addition	Number sentence
a	3 groups of 10	$10 + 10 + 10$	$(3 \times 10 = 30)$
b	4 groups of 7	$(7 + 7 + 7 + 7)$	$4 \times 7 = 28$
c	(3 groups of 6)	$6 + 6 + 6$	$(3 \times 6 = 18)$
d	10 groups of 4	$(4 + 4 + 4 + 4 + 4 + 4 + 4 + 4 + 4 + 4)$	$(10 \times 4 = 40)$
e	(9 groups of 5)	$5 + 5 + 5 + 5 + 5 + 5 + 5 + 5 + 5$	$(9 \times 5 = 45)$

5 REFLECTION AND SUMMARY OF LESSON (5 MINUTES)

Call the whole class to attention and summarise the key concepts of the lesson.

Today we have learnt to multiply with 10 by identifying patterns (rules).

Lesson 20: Consolidation

Teacher's notes

This lesson allows for consolidation of the previous days' lesson content.

CAPS topics: 1.2 Count forwards and backwards; 1.14 Repeated addition leading to multiplication.

Lesson Objective: Consolidate understanding of multiplication.

Lesson Vocabulary: Multiples, calculate, multiply, times, array, pattern.

Resources: Multiplication cards (see *Printable Resources*)

Date:

Week

Day

1 NOTES FOR THE TEACHER RELATING TO THIS WEEK'S WORK

The focus for this week's lessons was the patterns that are evident in multiplication. Learners used the multiplication table to help them identify patterns and to recognise how these patterns can be seen as rules to help you work out multiples. Learners used array diagrams to identify patterns, and to recognise how these patterns can be seen as rules such as the commutative and distributive laws of multiplication.

2 POSSIBLE MISCONCEPTIONS LINKED TO THE WEEK'S WORK

Learners may continue to add numbers rather than multiply numbers. Ensure that you have emphasised the verbalising of the concept of multiplication by getting learners to talk about (for example) "4 groups of 6" so that they can clarify the difference between multiplication and addition.

3 CLASSWORK/HOMEWORK – COMPLETE THIS WEEK'S CLASSWORK AS NEEDED

Today we are going over what we learned this week. We are learning more about patterns (rules) in multiplication.

Rules for the SNAP game

Give each pair of learners a full set of 1-9 multiplication cards.

Deal out the cards evenly between 2 learners.

Each learner must lay down a card on the desk, number sentence side facing up.

When the cards have the same numbers in a different order, the learners must say SNAP.

For example these two cards represent the same number:

$$4 \times 5$$

$$5 \times 4$$

The first learner to say SNAP keeps all the cards that have already been turned over.
The game is over when one learner has finished all their cards.

4 ADDITIONAL ACTIVITIES FOR CONSOLIDATION – SEE LEARNER RESOURCES

1 Write the number sentences:

	Repeated addition	Number sentence
a	6 groups of 8	$(6 \times 8 = 48)$
b	4 groups of 2	$(4 \times 2 = 8)$
c	$5 + 5 + 5 + 5 + 5 + 5 + 5 + 5$	$(8 \times 5 = 40)$
d	2 groups of 7	$(2 \times 7 = 14)$
e	$3 + 3 + 3 + 3$	$(4 \times 3 = 12)$
f	$9 + 9 + 9$	$(3 \times 9 = 27)$
g	9 groups of 8	$(9 \times 8 = 72)$
h	10 groups of 6	$(10 \times 6 = 60)$
i	$4 + 4 + 4 + 4 + 4 + 4 + 4$	$(7 \times 4 = 28)$
j	$10 + 10 + 10 + 10 + 10$	$(5 \times 10 = 50)$
k	9 groups of 1	$(9 \times 1 = 9)$
l	8 groups of 2	$(8 \times 2 = 16)$
m	$7 + 7 + 7 + 7 + 7 + 7$	$(6 \times 7 = 42)$
n	$6 + 6 + 6 + 6 + 6 + 6 + 6$	$(7 \times 6 = 42)$
o	5 groups of 4	$(5 \times 4 = 20)$
p	7 groups of 9	$(7 \times 9 = 63)$

2 In pairs play ‘SNAP’ with the multiplication cards. Your teacher will explain the rules.

5 REFLECTION AND SUMMARY OF LESSON

Call the whole class to attention and summarise the key concepts of the lesson.

Today we have learnt to multiply with 10 by identifying patterns (rules).

Week 5

Lesson 21: Assessment

Teacher's notes

This lesson should be used for assessment of the content covered in this unit to date.

CAPS topics: 1.2 Count forwards and backwards; 1.14 Repeated addition leading to multiplication.

Resources: Printable assessment in teacher's resources.

Date:

Week

Day

1 SETTLE THE CLASS AND ADMINISTER THE ASSESSMENT. (45 MINUTES)

The assessment for today is linked to the work covered in the unit to date.

You will find the printable version of the assessment in the teacher's resource pack.

2 DISCUSS ASSESSMENT ITEMS WITH THE CLASS (45 MINUTES)

Take in the learners' work when they are done.

There should be time for you to discuss a few of the items with the class:

- use this opportunity to reflect on different methods used by learners (allow some learners to write their solutions on the board).
- speak about misconceptions that may have arisen in learners' responses.

3 ASSESSMENT

WRITTEN ASSESSMENT (18)

1 Calculate:

(8)

a	$10 \times 7 =$	(70)
c	$3 \times 10 =$	(30)
e	$10 \times 10 =$	(100)
g	$1 \times 10 =$	(10)

b	$10 \times 2 =$	(20)
d	$5 \times 10 =$	(50)
f	$9 \times 10 =$	(90)
h	$10 \times 5 =$	(50)

2 Complete the table:

(10)

		Repeated addition	Number sentence
a	4 groups of 6	$(6 + 6 + 6 + 6)$	$4 \times 6 = 24$
b	2 groups of 4	$4 + 4$	$(2 \times 4 = 8)$
c	(3 groups of 10)	$10 + 10 + 10$	$3 \times 10 = 30$
d	5 groups of 7	$(7 + 7 + 7 + 7 + 7)$	$(5 \times 7 = 35)$
e	10 groups of 6	$6 + 6 + 6 + 6 + 6 + 6 + 6 + 6 + 6 + 6$	$(10 \times 6 = 60)$
f	4 groups of 9	$(9 + 9 + 9 + 9)$	$4 \times 9 = 36$
g	(8 groups of 5)	$5 + 5 + 5 + 5 + 5 + 5 + 5 + 5$	$(8 \times 5 = 40)$
h	9 groups of 8	$8 + 8 + 8 + 8 + 8 + 8 + 8 + 8 + 8$	$(9 \times 8 = 72)$

Lesson 22: Multiply by 0 and find the missing number

Teacher's notes

This lesson is one of the fully planned lessons to be used to cover the Term 2 curriculum.

CAPS topics: 1.2 Count forwards and backwards; 1.14 Repeated addition leading to multiplication.

Lesson Objective: Develop an understanding of the patterns (rules) associated with multiplying by 0.

Lesson Vocabulary: Multiples, calculate, multiply, times, array, pattern.

Resources: Multiplication table (see *Printable Resources*).

Date:

Week

Day

1 MENTAL MATHS (10 MINUTES)

	Count backwards in:	Answer
1	2s from 10 - 0	10, 8, 6, 4, 2, 0
2	3s from 15 - 0	15, 12, 9, 6, 3, 0
3	4s from 20 - 0	20, 16, 12, 8, 4, 0
4	5s from 25 - 0	25, 20, 15, 10, 5, 0

2 LESSON CONTENT - CONCEPT DEVELOPMENT (45 MINUTES)

In today's lesson, learners will continue to investigate patterns in multiplication. The focus in this lesson is on multiplying by 0. Ensure that learners are exposed to 0 as the number of groups as well as the number in the group.

Today we are learning about patterns (rules) when multiplying by 0.

Activity 1: Whole class activity

- Use the table that you drew on the board for Lesson 18.
- *In today's lesson we will only focus on the first and fourth rows (the rows containing a zero). The second and third scores (i.e. the rows containing the number 10) have already been dealt with in Lesson 18.*

Score	Darts	Total
	0	0
4	10	40
10	4	30
0	7	0

- We are continuing to work with the scores in the darts game Siphso played. Explain that if you miss the board, you score 0.

- Ask: **If Sipho threw 7 darts that missed the board, he scored 0 with 7 darts.**
(Encourage the learners to discuss how they could work out how many points were scored in total from these throws).
- Ask: **What's the total score for 7 darts with a score of 0?** (7×0 is 0 which means when we have a 0 score 7 times, we get $7 \times 0 = 0$)
- *Note that in this problem the 0 is the score per dart, $7 \times 0 = 0$.*
- Ask: **What's the total score for score 0 thrown?** (0 groups of anything is zero because you have no groups, you have 0; $0 \times \dots = 0$)
- *Note that in this problem the 0 is the number of darts, $0 \times \dots = 0$.*

Activity 2: Learners work in groups

- Write the following questions on the board.
- Let learners solve them.

a $10 \times 2 = (20)$	b $5 \times 0 = (0)$	c $4 \times 10 = (40)$	d $0 \times 4 = (0)$
e $9 \times 0 = (0)$	f $10 \times 7 = (70)$	g $0 \times 8 = (0)$	h $9 \times 10 = (90)$
- Ask: **What do you notice about multiplying 10 and 0?**
- Discuss. For example:
- If we multiply by 10, the number in the ones place moves to the tens place (e.g. $10 \times 2 = 20$, the number 2 in the ones place moves to the tens place and the answer is 20).
- If we multiply any number by 0, the answer is 0.)

Activity 3: Learners work in pairs

- Give each pair of learners a multiplication table.
- Write the following problem on the board:
 $\square \times 2 = 14$
- Ask: **How can we work out what the missing number is?** (We go down the column of 2 until we reach the 14. The number of the row that 14 is on will be the missing number. The missing number is 7).
- Learners write the problem and the answer in their classwork book.
- Write the following problem on the board:
 $3 \times \square = 21$
- Ask: **How can we work out what the missing number is?** (We go along the row of 3 until we get to the 21. The number of the column that 21 is on will be the missing number. The missing number is 7).
- Learners write the problem and the answer in their classwork book.

3 CLASSWORK ACTIVITY AND CORRECTION OF HOMEWORK (25 MINUTES)

Note: If learners have already memorised the multiplication tables and can find the answers mentally when they do this activity, it is fine.

1 Use your multiplication table to find the missing numbers:

		Answer
a	$\square \times 3 = 18$	(6)
c	$7 \times \square = 14$	(2)
e	$\square \times 9 = 36$	(4)
g	$\square \times 4 = 20$	(5)
i	$8 \times \square = 24$	(3)
k	$\square \times 5 = 15$	(3)
m	$2 \times \square = 18$	(9)
o	$\square \times 7 = 28$	(4)

		Answer
b	$5 \times \square = 35$	(7)
d	$\square \times 6 = 18$	(3)
f	$4 \times \square = 32$	(8)
h	$3 \times \square = 27$	(9)
j	$\square \times 6 = 42$	(7)
l	$\square \times 5 = 45$	(9)
n	$8 \times \square = 64$	(8)
p	$2 \times \square = 12$	(6)

2 Calculate:

- a** $0 \times 5 = (0)$
- b** $4 \times 10 = (40)$
- c** $0 \times 3 = (0)$
- d** $10 \times 6 = (60)$
- e** $0 \times 10 = (0)$
- f** $8 \times 10 = (80)$

4 HOMEWORK ACTIVITY (5 MINUTES)

Calculate:

- a** $0 \times 6 = (0)$
- b** $7 \times 10 = (70)$
- c** $0 \times 2 = (0)$
- d** $10 \times 5 = (50)$
- e** $10 \times 0 = (0)$
- f** $9 \times 10 = (90)$

5 REFLECTION AND SUMMARY OF LESSON (5 MINUTES)

Call the whole class to attention and summarise the key concepts of the lesson.

Today we have learnt to multiply with 0 by identifying patterns (rules).

Lesson 23: More multiplication patterns

Teacher's notes

This lesson is one of the fully planned lessons to be used to cover the Term 2 curriculum.

CAPS topics: 1.2 Count forwards and backwards; 1.14 Repeated addition leading to multiplication.

Lesson Objective: Develop an understanding of the distributive law.

Lesson Vocabulary: multiples, calculate, multiply, times, array, pattern.

Resources: Multiplication table (see *Printable Resources*).

Date:

Week

Day

1 MENTAL MATHS (10 MINUTES)

	Calculate:	Answer			Answer
1	3×7	21	6	8×8	64
2	4×2	8	7	9×4	36
3	6×9	54	8	7×6	42
4	8×7	56	9	1×9	9
5	7×1	7	10	8×3	24

2 LESSON CONTENT - CONCEPT DEVELOPMENT (45 MINUTES)

In today's lesson, learners will continue to investigate patterns in multiplication. The focus in this lesson is on the distributive law of multiplication. Learners do not need to learn the name of the law but they need to learn that multiplication is distributive. Ensure that learners are given opportunities to experience (for example) $8 \times (4 + 2)$ as being equal to $(8 \times 4) + (8 \times 2)$. *You should also refer to the tracker for the summary of the problem solving approach used in this lesson.*

Today we are learning about the distributive law of multiplication.

Activity 1: Learners work in groups

- Write the following problem on the chalkboard:
There are 4 bags.
Each bag contains 3 blue marbles and 2 yellow marbles.
- *The word problem must be written on three lines as shown above to assist learners to identify the critical information/numbers needed to solve the problem.*
- Read the problem.
- Let the learners read the problem until they read it fluently.

- Underline the numbers (4, 3 and 2).
- Let learners find the total number of marbles in two different ways.
 - a Find the number of marbles in each bag first and then find the total number.
 - b Find the total number of marbles of each colour first and then find the total number.
- Let learners draw circles in array. Let them draw circles to explain the difference.

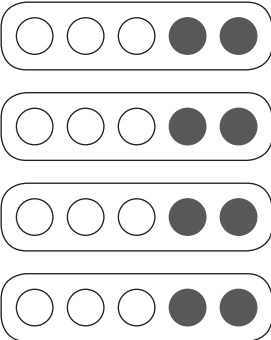
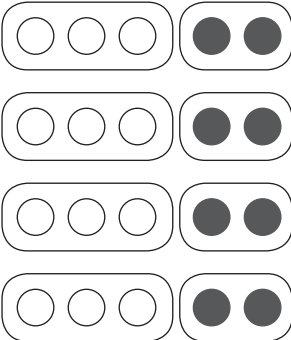
a Find the number of marbles in each bag first.	b Find the the total number of each colour first.
	

- If learners can't find the answer, ask following questions to help them think through each of the two ways of finding the solution.
 - a Find the number of marbles in each bag first.
 - Ask: **How many marbles in each bag?** ($3 + 2 = 5$).
 - Ask: **How many marbles are there altogether?** ($4 \times 5 = 20$ marbles).
 - b Find the total number of each colour first.
 - Ask: **Can you work out the total number of blue marbles?** ($4 \times 3 = 12$).
 - Ask: **Can you work out the total number of yellow marbles?** ($4 \times 2 = 8$).
 - Ask: **How many marbles do we have altogether?** (We have $12 + 8 = 20$ marbles).
- Let the learners write the number sentence.
- Confirm the number sentence with the learners, i.e. $4 \times (3 + 2) = (4 \times 3) + (4 \times 2) = 20$.
- Learners may have forgotten the meaning of a bracket. Remind them of the meaning, i.e. you must calculate what is inside the bracket first.

Activity 2: Learners work in groups

- Find the answers to the following. Then compare if they are the same or not.

Number sentence	Answer	Number sentence	Answer
a $3 \times (2 + 4) =$	(18)	b $(3 \times 2) + (3 \times 4) =$	(18)
c $4 \times (6 + 3) =$	(36)	d $(4 \times 6) + (4 \times 3) =$	(36)
e $8 \times (3 + 4) =$	(56)	f $(8 \times 3) + (8 \times 4) =$	(56)

3 CLASSWORK ACTIVITY AND CORRECTION OF HOMEWORK (25 MINUTES)

Use your multiplication table to find the missing numbers:

		Answer
a	$\square \times 4 = 28$	(7)
c	$2 \times \square = 18$	(9)
e	$\square \times 7 = 49$	(7)
g	$\square \times 8 = 48$	(6)
i	$9 \times \square = 45$	(5)
k	$\square \times 3 = 12$	(4)
m	$6 \times \square = 18$	(3)
o	$\square \times 9 = 72$	(8)

		Answer
b	$5 \times \square = 40$	(8)
d	$\square \times 6 = 36$	(6)
f	$2 \times \square = 10$	(5)
h	$7 \times \square = 21$	(3)
j	$\square \times 2 = 12$	(6)
l	$\square \times 6 = 54$	(9)
n	$4 \times \square = 16$	(4)
p	$8 \times \square = 32$	(4)

4 HOMEWORK ACTIVITY (5 MINUTES)

<p>I have 3 bunches of flowers. In each bunch there are 3 pink flowers and 4 white flowers. How many flowers do I have altogether?</p>	
<p>Draw a diagram.</p>	
<p>Write the number sentences.</p>	<p>$(3 \times 3 = 9)$ $(3 \times 4 = 12)$ $(9 + 12 = 21)$</p>
<p>Write the answer.</p>	<p>(21 flowers in total)</p>

5 REFLECTION AND SUMMARY OF LESSON (5 MINUTES)

Call the whole class to attention and summarise the key concepts of the lesson.

Today we have learnt about the distributive law.

Lesson 24: Assessment

Teacher's notes

This lesson should be used for assessment of the content covered in this unit to date.

CAPS topics: 1.2 Count forwards and backwards; 1.14 Repeated addition leading to multiplication.

Resources: Printable assessment in teacher's resources.

Date:

Week

Day

1 SETTLE THE CLASS AND ADMINISTER THE ASSESSMENT. (45 MINUTES)

The assessment for today is linked to the work covered in the unit to date.

You will find the printable version of the assessment in the teacher's resource pack.

2 DISCUSS ASSESSMENT ITEMS WITH THE CLASS (45 MINUTES)

Take in the learners' work when they are done.

There should be time for you to discuss a few of the items with the class:

- use this opportunity to reflect on different methods used by learners (allow some learners to write their solutions on the board).
- speak about misconceptions that may have arisen in learners' responses.

3 ASSESSMENT

WRITTEN ASSESSMENT (18)

Note: learners can use their multiplication tables in this assessment if they would like to.

- 1 Draw a line between number sentences that give the same answer: (8)

3×5	8×6
7×4	2×5
6×8	4×9
9×1	5×3
5×2	4×7
6×3	7×8
8×7	1×9
9×4	3×6

(Answer)

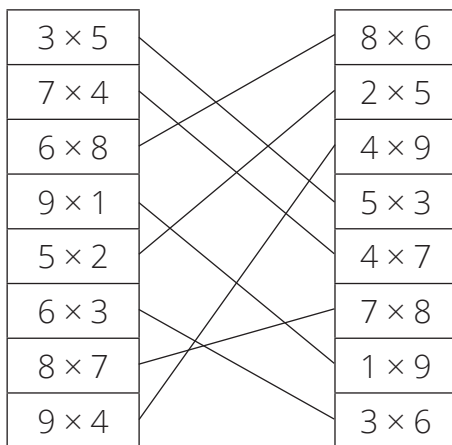

2 Use your multiplication table to find the missing numbers: (6)

		Answer
a	$\square \times 5 = 35$	(7)
c	$7 \times \square = 28$	(4)
e	$\square \times 2 = 14$	(7)

		Answer
b	$6 \times \square = 36$	(6)
d	$\square \times 8 = 72$	(9)
f	$5 \times \square = 30$	(6)

3 Draw an array diagram to show: (4)

		Array												
a	3×2	<table border="1"> <tr><td></td><td>1</td><td>2</td></tr> <tr><td>1</td><td>●</td><td>●</td></tr> <tr><td>2</td><td>●</td><td>●</td></tr> <tr><td>3</td><td>●</td><td>●</td></tr> </table>		1	2	1	●	●	2	●	●	3	●	●
	1	2												
1	●	●												
2	●	●												
3	●	●												
c	5×1	<table border="1"> <tr><td></td><td>1</td></tr> <tr><td>1</td><td>●</td></tr> <tr><td>2</td><td>●</td></tr> <tr><td>3</td><td>●</td></tr> <tr><td>4</td><td>●</td></tr> <tr><td>5</td><td>●</td></tr> </table>		1	1	●	2	●	3	●	4	●	5	●
	1													
1	●													
2	●													
3	●													
4	●													
5	●													

		Array												
b	2×3	<table border="1"> <tr><td></td><td>1</td><td>2</td><td>3</td></tr> <tr><td>1</td><td>●</td><td>●</td><td>●</td></tr> <tr><td>2</td><td>●</td><td>●</td><td>●</td></tr> </table>		1	2	3	1	●	●	●	2	●	●	●
	1	2	3											
1	●	●	●											
2	●	●	●											
d	1×5	<table border="1"> <tr><td></td><td>1</td><td>2</td><td>3</td><td>4</td><td>5</td></tr> <tr><td>1</td><td>●</td><td>●</td><td>●</td><td>●</td><td>●</td></tr> </table>		1	2	3	4	5	1	●	●	●	●	●
	1	2	3	4	5									
1	●	●	●	●	●									

Lesson 25: Consolidation

Teacher's notes

This lesson allows for consolidation of the previous days' lesson content.

CAPS topics: 1.2 Count forwards and backwards; 1.14 Repeated addition leading to multiplication.

Lesson Objective: Revise multiplication.

Lesson Vocabulary: multiples, calculate, multiply, times, array, pattern.

Resources: Multiplication table (see *Printable Resources*).

Date:

Week

Day

1 NOTES FOR THE TEACHER RELATING TO THIS WEEK'S WORK

The focus for this week's lessons continued to be on patterns evident in multiplication. Learners used array diagrams to identify patterns, and to recognise how these patterns can be seen as rules for multiplication by 10 or by 0. They also used their multiplication tables to find missing numbers in given number sentences.

2 POSSIBLE MISCONCEPTIONS LINKED TO THE WEEK'S WORK

Learners may continue to add numbers rather than multiply numbers. Ensure that you have emphasised the verbalising of the concept of multiplication by getting learners to talk about (for example) "3 groups of 5" as compared to "5 groups of 3".

3 CLASSWORK/HOMEWORK – COMPLETE THIS WEEK'S CLASSWORK AS NEEDED

Today we are going over what we learned this week. We are learning more about commutative and distributive laws of multiplication.

4 ADDITIONAL ACTIVITIES FOR CONSOLIDATION – SEE LEARNER RESOURCES

1 Use your multiplication table to find the missing numbers:

		Answer
a	$\square \times 9 = 54$	(6)
c	$\square \times 7 = 21$	(3)

		Answer
b	$3 \times \square = 12$	(4)
d	$4 \times \square = 36$	(9)

2 Draw an array diagram to show:

		Array																																								
a	6×2	<table border="1"> <tr><td></td><td>1</td><td>2</td></tr> <tr><td>1</td><td>●</td><td>●</td></tr> <tr><td>2</td><td>●</td><td>●</td></tr> <tr><td>3</td><td>●</td><td>●</td></tr> <tr><td>4</td><td>●</td><td>●</td></tr> <tr><td>5</td><td>●</td><td>●</td></tr> <tr><td>6</td><td>●</td><td>●</td></tr> </table>		1	2	1	●	●	2	●	●	3	●	●	4	●	●	5	●	●	6	●	●																			
	1	2																																								
1	●	●																																								
2	●	●																																								
3	●	●																																								
4	●	●																																								
5	●	●																																								
6	●	●																																								
b	2×6	<table border="1"> <tr><td></td><td>1</td><td>2</td><td>3</td><td>4</td><td>5</td><td>6</td></tr> <tr><td>1</td><td>●</td><td>●</td><td>●</td><td>●</td><td>●</td><td>●</td></tr> <tr><td>2</td><td>●</td><td>●</td><td>●</td><td>●</td><td>●</td><td>●</td></tr> </table>		1	2	3	4	5	6	1	●	●	●	●	●	●	2	●	●	●	●	●	●																			
	1	2	3	4	5	6																																				
1	●	●	●	●	●	●																																				
2	●	●	●	●	●	●																																				
c	7×4	<table border="1"> <tr><td></td><td>1</td><td>2</td><td>3</td><td>4</td></tr> <tr><td>1</td><td>●</td><td>●</td><td>●</td><td>●</td></tr> <tr><td>2</td><td>●</td><td>●</td><td>●</td><td>●</td></tr> <tr><td>3</td><td>●</td><td>●</td><td>●</td><td>●</td></tr> <tr><td>4</td><td>●</td><td>●</td><td>●</td><td>●</td></tr> <tr><td>5</td><td>●</td><td>●</td><td>●</td><td>●</td></tr> <tr><td>6</td><td>●</td><td>●</td><td>●</td><td>●</td></tr> <tr><td>7</td><td>●</td><td>●</td><td>●</td><td>●</td></tr> </table>		1	2	3	4	1	●	●	●	●	2	●	●	●	●	3	●	●	●	●	4	●	●	●	●	5	●	●	●	●	6	●	●	●	●	7	●	●	●	●
	1	2	3	4																																						
1	●	●	●	●																																						
2	●	●	●	●																																						
3	●	●	●	●																																						
4	●	●	●	●																																						
5	●	●	●	●																																						
6	●	●	●	●																																						
7	●	●	●	●																																						
d	4×7	<table border="1"> <tr><td></td><td>1</td><td>2</td><td>3</td><td>4</td><td>5</td><td>6</td><td>7</td></tr> <tr><td>1</td><td>●</td><td>●</td><td>●</td><td>●</td><td>●</td><td>●</td><td>●</td></tr> <tr><td>2</td><td>●</td><td>●</td><td>●</td><td>●</td><td>●</td><td>●</td><td>●</td></tr> <tr><td>3</td><td>●</td><td>●</td><td>●</td><td>●</td><td>●</td><td>●</td><td>●</td></tr> <tr><td>4</td><td>●</td><td>●</td><td>●</td><td>●</td><td>●</td><td>●</td><td>●</td></tr> </table>		1	2	3	4	5	6	7	1	●	●	●	●	●	●	●	2	●	●	●	●	●	●	●	3	●	●	●	●	●	●	●	4	●	●	●	●	●	●	●
	1	2	3	4	5	6	7																																			
1	●	●	●	●	●	●	●																																			
2	●	●	●	●	●	●	●																																			
3	●	●	●	●	●	●	●																																			
4	●	●	●	●	●	●	●																																			

3 Solve the problem:

<p>I have 4 bags of shapes. In each bag there are 2 triangles and 5 rectangles. How many shapes do I have altogether?</p>	
<p>Draw a diagram</p>	
<p>Write the number sentences</p>	<p>$(4 \times 2 = 8)$ $(4 \times 5 = 20)$ $(8 + 20 = 28)$</p>
<p>Write the answer</p>	<p>(28 shapes in total) $(2 + 5 = 7)$ $(4 \times 7 = 28)$</p>

WEEK 5

5 REFLECTION AND SUMMARY OF LESSON

Call the whole class to attention and summarise the key concepts of the lesson.

Today we have revised multiplication.

Week 6

Unit 3 Introduction

In this unit, learners will learn about time. Time is part of measurement. We measure quantities of food ingredients (mass), time, objects (various aspects, e.g. capacity and mass) and space (e.g. volume). Learners learn maths and measurement skills before they learn the words that represent what they are doing. The teaching of time is a difficult one because you cannot see or touch 'time'. The learners may become frustrated with the task of learning to tell time and teachers become frustrated with how difficult it is to teach time. The concepts of time include telling the time and measuring elapsed/passing time. Time is an abstract concept. As teachers, we need to "show" learners time by using physical aids such as clocks and calendars. Telling time is an essential life skill.

In this unit you will be able to focus on the four framework dimensions in the following way:

- **Conceptual understanding:** This unit addresses the key concept of time.
- **Procedural fluency:** Learners will develop procedural fluency in the ability to tell the time and measure time passed through doing a variety of tasks.
- **Strategies:** Learners will discover that measuring time involves many units, such as minute and hours. Minutes are often grouped when telling the time, into 5s, 10s, 15s and so on.
- **Reasoning:** Learners are given opportunities to reason mathematically when they work with the units of time.

Building a **learning centred classroom** in this unit will involve (amongst other things) attention to:

- **Concept development:** Learners need opportunities to construct their own understanding of measuring time through thinking and reasoning. For example, when the teacher asks **How much time has passed?** learners need to reason and create a connection between telling and measuring time.
- **Making sense of mathematics:** In this unit, learners are making sense of mathematics as they deepen their knowledge of speaking about time. This knowledge relates to real-life situations. Being able to measure time is part of what we do every day, which helps learners to see Mathematics as an important part of life, rather than just a school subject.
- **Purposeful assessment:** The concept of time is abstract and yet it is part of our daily lives. Assessment of learners' ability to tell the time and work with the units of time should be related to meaningful daily experiences to help them make sense of the concept of time.

Lesson 26: Time

Teacher's notes

This lesson is one of the fully planned lessons to be used to cover the Term 2 curriculum.

CAPS topics: 4.1 Time.

Lesson Objective: To tell the time using analogue and digital clocks.

Lesson Vocabulary: Analogue time, digital time, hour(s), half hour(s), quarter hour(s), minute(s), clock, o'clock, analogue clock, digital clock, am, pm.

Resources: Analogue and digital clocks.

Date:

Week

Day

1 MENTAL MATHS (10 MINUTES)

	How many ...	Answer		What is ... in hours?	Answer
1	Minutes in $\frac{1}{2}$ of an hour?	30	6	60 minutes	1 hour
2	Minutes in $\frac{1}{4}$ of an hour?	15	7	30 minute	$\frac{1}{2}$ hour
3	Minutes in $\frac{3}{4}$ of an hour?	35	8	15 minutes	$\frac{1}{4}$ hour
4	Minutes in $\frac{2}{4}$ of an hour?	30	9	120 minutes	2 hours
5	Minutes in an hour?	30	10	45 minutes	$\frac{3}{4}$ hour

2 LESSON CONTENT - CONCEPT DEVELOPMENT (45 MINUTES)

This is the first of four lessons on time. Learners will consolidate their knowledge of telling the time. They will use both analogue and digital clocks. Using these clocks learners will learn the concept of time (hours, half hours, quarter hours and minutes.) It is very important that the learners experience learning how to tell the time by being able to work with a "real" clock. Learners learn best when they are actively involved in their learning. In Activity 2 of this lesson you explain different kinds of clocks to the class. This discussion can be simplified if necessary – you should link it to the actual experience of learners in your class – according to the kinds of clocks they tell you they have seen and used.

Today we are learning to tell the time using analogue and digital clocks.

Activity 1: Whole class activity

- In this activity you will revise analogue time. You should have an analogue clock to show to your class. Tell them it is called an analogue clock and compare it to a digital clock, which you will talk about in the next activity of this lesson.
- Talk about the differences between the two kinds of clocks.
- Ask questions such as:

- **How many minutes are there in an hour?** (60).
- **What do we mean when we say 4 o'clock?** (That the time is exactly on the hour – not before or after.)
- **Show me 4 o'clock on this clock.** (Get learners to come to the front of the class to demonstrate where the hands on the analogue clock should be to show the time.)
- **How many minutes in half an hour?** (30)
- **When we read time, how do we say half an hour from the full hour or the o'clock?** (half past)
- **On this clock show any time that includes *half past* and read the time to me.** (Ask a learner to come to the front and demonstrate how to show e.g. half past three.)
- **Show me a time that is *quarter past* and *quarter to*.** (Ask a learner to come to the front and demonstrate.)

Activity 2: Whole class activity

- Compile a table like the one below on the board before the lesson. The digital clock column will be filled during the lesson.
- Ask if any learners can read the time on cell phones, microwave ovens, etc. Discuss digital clocks by covering the following points:
- Digital clocks can work in 24-hour cycles – day and night. So we see any hour only once. On an analogue clock we have 12 hours for a.m. (morning) and 12 hours for p.m. (afternoon) but on the 24-hour digital clock these are put together and we have 24 hours.
- There are also 12-hour digital clocks, where day and night times do not look different: 08:00 could be 8 o'clock in the morning or night. We will write times using a 12-hour digital format.
- If you had two watches, one analogue and one digital, and you need to show 8 o'clock in the morning, this is how it would look. (First show this on actual clocks, and then draw a clock face showing 8 o'clock for the analogue clock, and write 08:00 to show digital time next to it.)
- Use analogue and digital clocks to show every hour, and ask learners to have a go at helping you to complete a table on the board from 01:00–12:00.

Time in words	Digital clock
midnight	0:00
quarter past twelve	12:15
half past twelve	12:30
quarter to one	12:45
one o'clock	01:00
midday	12:00

Activity 3: Whole class activity

- Ask learners how we write these times in digital time:
 - half past three (3:30)
 - quarter past three (3:15)
- Ask: **How do we write these times in analogue time:**
 - **07:45** (quarter to 8)
 - **12:00?** (twelve o'clock)

3 CLASSWORK ACTIVITY AND CORRECTION OF HOMEWORK (25 MINUTES)

NOTE: These activities relate to a digital clock which is a 12 hour clock, so there is not a difference between morning and afternoon.

- 1 Write these times as digital times:
 - a Half past seven. (7:30)
 - b Quarter past seven. (7:15)
 - c Quarter to 4. (3:45)
 - d Quarter past four. (4:15)
 - e Half past 5. (5:30)
- 2 Write these times as analogue times:
 - a 05:30 (half past 5)
 - b 02:00 (two o'clock)
 - c 12:00 (twelve o'clock)
 - d 07:00 (seven o'clock)
- 3 Show quarter past two on the clock:



- a Write the time below the clock. (2:15 or quarter past two)
- b How many minutes is it before 3 o'clock? (45 minutes)
- c Where is the hour hand pointing? (a little bit after 2)
- d Where is the minute hand pointing? (at 3)

4 HOMEWORK ACTIVITY (5 MINUTES)

1 Show on the clock faces below:

a 10 o'clock



b 12 o'clock

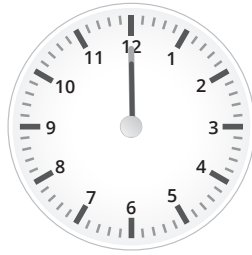

c 5 o'clock

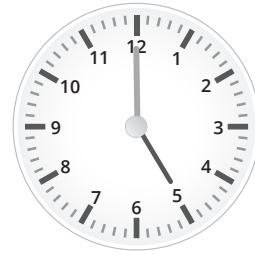

2 Write the times shown on these clocks:

a

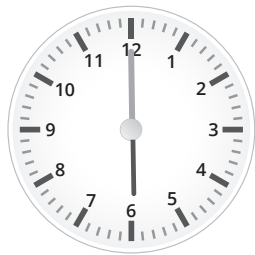

(6 o'clock)

b

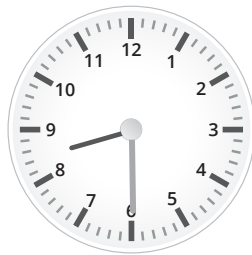

(half past eight)

c

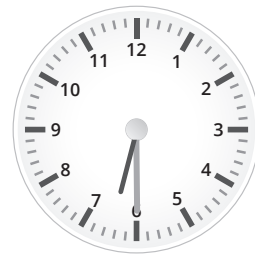

(half past six)

5 REFLECTION AND SUMMARY OF LESSON (5 MINUTES)

Call the whole class to attention and summarise the key concepts of the lesson.

Today we have learnt to tell the time using analogue and digital watches.

Lesson 27: Measuring Time

Teacher's notes

This lesson is one of the fully planned lessons to be used to cover the Term 2 curriculum.

CAPS topics: 4.1 Time.

Lesson Objective: To measure and compare the concepts of measuring time.

Lesson Vocabulary: Time, 12-hour time, hours, half hours, quarters, minutes, analogue clock.

Resources: Analogue and digital clocks.

Date:

Week

Day

1 MENTAL MATHS (10 MINUTES)

	What is 5 less than ...	Answer		What is 5 more than ...	Answer
1	30	25	6	30	35
2	45	40	7	45	50
3	50	45	8	50	55
4	60	55	9	60	65
5	25	20	10	25	30

2 LESSON CONTENT - CONCEPT DEVELOPMENT (45 MINUTES)

This is the second lesson on time. The learners will continue to work with both analogue and digital clocks. In both the activities and classwork, the learners will practise the working with the units of time, hours and minutes. They will also practise using the expressions half past, quarter to and quarter past to speak about times. It is important that learners realise the importance of being able to tell the time and work with the units of time. We can facilitate this by using examples that they can relate to. For example: what time does school begin?

Today we are learning to measure time.

Activity 1: Whole class activity

Use an example of an analogue clock. Revise reading time from an analogue clock by counting on in 5s:

- Ask: **How many minutes are there in an hour?** (60 minutes.)
- Say: **Let us count the minutes in one hour.** (Start counting the minutes from 12 to 1 and point to the numbers on the clock face as you count – 5, 10, 15, 20, 25, 30, 35, 40, 45, 50, 55, 60.)

- Ask: **How many minutes are there in half an hour?** (30 minutes.)
- Say: **Let us count the minutes in half an hour:** (Start counting the minutes from 12 to 1 and point to the numbers on the clock face as you count – 5, 10, 15, 20, 25, 30.)
- Ask: **Can I count 30 minutes starting from another place on the clock?** (Yes – discuss possibilities and try them out.)
- Ask: **How many minutes are there in a quarter of an hour?** (15 minutes.)
- Say: **Let us count 15 minutes:** (Start counting from 12 to 1 and point to the numbers on the clock face as you count – 5, 10, 15.)
- Ask: **Can I count 15 minutes starting from another place on the clock?** (Yes – discuss possibilities and try them out.)

Activity 2: Whole class activity





Refer to the clocks in Activity 1 of the Learner Activity Book.



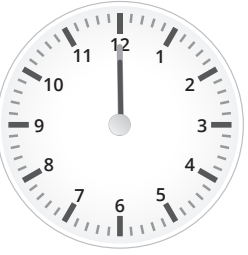
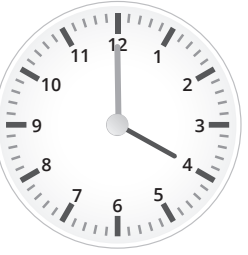

Revise the following with the learners.

- How to read the time.
- The drawings show analogue and digital clock faces.
- Discuss each of the times that is shown with the class, making sure that learners are able to read the time correctly.

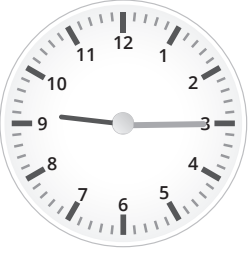
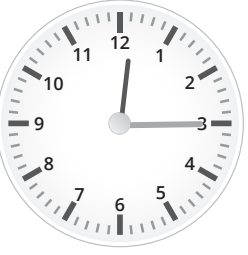
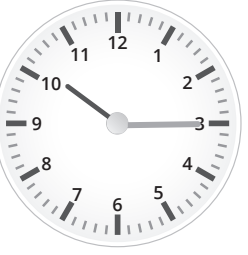
3 CLASSWORK ACTIVITY AND CORRECTION OF HOMEWORK (25 MINUTES)

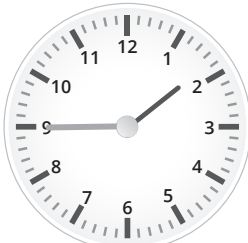
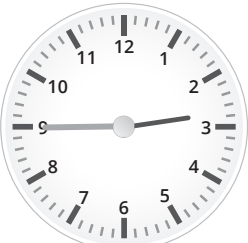
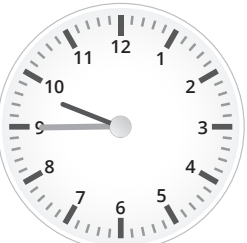
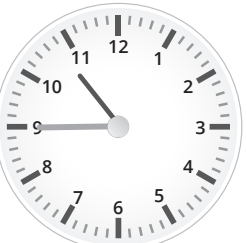
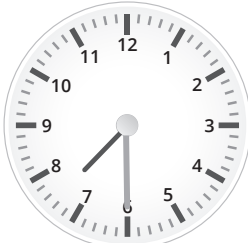
Clock faces for classwork activity.

___ o'clock			
			
08:00	11:00	12:00	04:00
quarter past ___			
			
04:15	09:15	12:15	10:15

quarter to ____			
			
01:45	02:45	09:45	10:45
half past ____			
			
07:30	10:30	02:30	06:30

CLASSWORK

1 What is the time? Write the time in words.

a

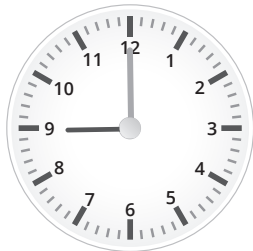

(9/nine o'clock)

b

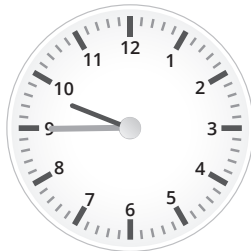

(quarter to ten/10)

c

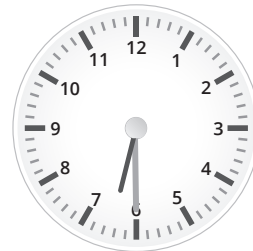

(half past six/6)

2 Show the times on the clock faces: (Learners should draw clock faces with the arms in the correct positions for the times given below.)

a Ten o'clock



b Quarter to twelve

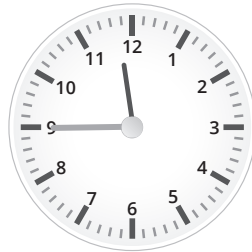

c Nine minutes to one



d 17:35

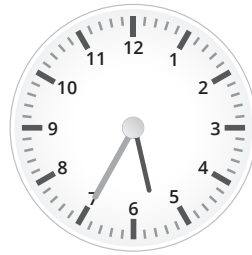

4 HOMEWORK ACTIVITY (5 MINUTES)

1 What is the time? Write the time in words.

a

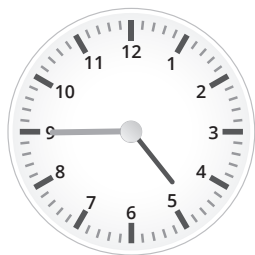

(quarter to 5/five)

b

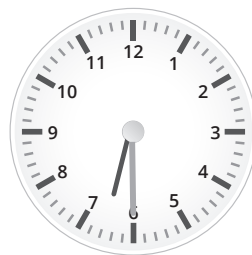

(half past 6/six)

2 Show the times on the clock faces: (Learners should draw clock faces with the arms in the correct positions for the times given below.)

a 9 minutes past 1

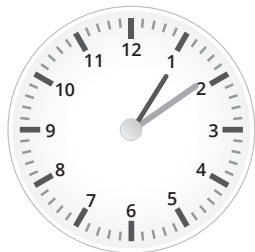

b Quarter to three



c Four minutes past five

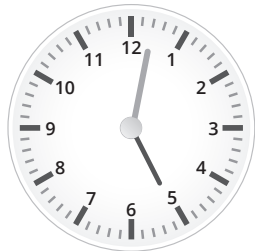

d 15 minutes to 5

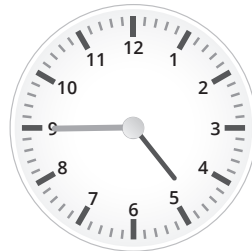

5 REFLECTION AND SUMMARY OF LESSON (5 MINUTES)

Call the whole class to attention and summarise the key concepts of the lesson.

Today we have learnt to measure time.

Lesson 28: Time passed

Teacher's notes

This lesson is one of the fully planned lessons to be used to cover the Term 2 curriculum.

CAPS topics: 4.1 Time.

Lesson Objective: To calculate elapsed time.

Lesson Vocabulary: Analogue time, digital time, hours, half hours, quarter hours, minutes, day(s), week(s), month(s), year(s), number line, breaking down.

Resources: Analogue and digital clocks.

Date:

Week

Day

1 MENTAL MATHS (10 MINUTES)

	What is 15 minutes later?	Answer		What is 15 minutes earlier?	Answer
1	3.30	3.45	6	3.30	3.15
2	1.00	1.15	7	1.00	12.45
3	4.45	5.00	8	4.45	4.30
4	6.15	6.30	9	6.15	6.00
5	7.00	7.15	10	7.00	6.45

2 LESSON CONTENT - CONCEPT DEVELOPMENT (45 MINUTES)

This is the third lesson on time. In this lesson you show learners three different ways to calculate time that has passed. You should show learners all three different ways but allow them to use the way they choose to do their own calculation in the classwork activity that follows.

Today we are learning to work out how much time has passed.

Activity 1: Whole class activity

- Method 1 demonstration – using a clock to calculate
- Write these questions on the board:
At what time does school start each day? (8:00)
At what time does school end each day? (1:30)
- Ask: **How many hours are we at school?**
- Use an analogue clock as an aid. Ask them to place the hands of their clocks on 8 o'clock. They then count the:
hours from 8 o'clock to 1 o'clock – 8:00, 9, 10, 11, 12, 1 → 5 hours and

then the minutes from 1:00 to 1:30 → half an hour.

- The time spent at school is 5 hours + half an hour = 5 ½ hours.

Activity 2: Whole class activity

- Method 2 demonstration – using a number line to calculate
- Write this question on the board:
Mom puts a cake into the oven at 3:45.
It needs to bake for 1¼ hours.
At what time must she take the cake out of the oven?

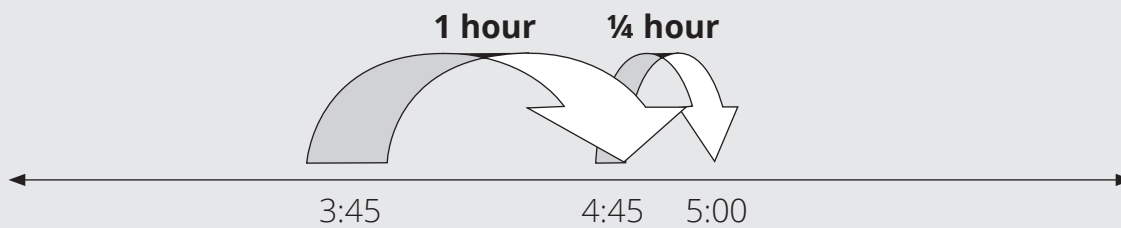

- Mum needs to take the cake out of the oven at 5:00

Activity 3: Whole class activity

- Method 3 demonstration – breaking down to calculate
- Write this question on the board:
Mpho takes 1½ hours to do her homework.
Jenny takes half that amount of time.
How long does Jenny take?
- 1½ hours = 1 hour + ½ hour
- Half of 1½ hours = half of 60 minutes + half of 30 minutes
= half of 90 minutes
= 45 minutes.
- Jenny takes 45 minutes.

3 CLASSWORK ACTIVITY AND CORRECTION OF HOMEWORK (25 MINUTES)

1 Write these times in digital time:

- Half past eight. (8:30)
- Quarter to six. (5:45)
- Quarter to 9. (8:45)
- Quarter past 2. (2:15)
- Half past four. (4:30)

2 Write these times in analogue time

- 05:15 (quarter past five)
- 02:45 (quarter to three)

- c** 12:15 (quarter past twelve)
- d** 07:30 (half past seven)
- 3** How many minutes in one hour? (60 minutes)
- 4** How many hours in one day? (24 hours)
- 5** How many days in one week? (7 days)
- 6** How many months in one year? (12 months)
- 7** Diksha leaves home at 7:15 and arrives at school at 8:00. How long did it take Diksha to get to school? (45 minutes)

4 HOMEWORK ACTIVITY (5 MINUTES)

- a** How many minutes in 2 hours? (120 minutes)
- b** How many hours in 2 days? (48 hours)
- c** How many days in 2 weeks? (14 days)
- d** How many months in 2 years? (24 months)

5 REFLECTION AND SUMMARY OF LESSON (5 MINUTES)

Call the whole class to attention and summarise the key concepts of the lesson.

Today we have learnt to calculate how much time has passed.

Lesson 29: Calendars

Teacher's notes

This lesson is one of the fully planned lessons to be used to cover the Term 2 curriculum.

CAPS topics: 4.1 Time.

Lesson Objective: To use calendars to calculate and describe lengths of time in days or weeks or months.

Lesson Vocabulary: Time, calendars, religious festivals, public holidays, historical events, weeks, months, forwards, backwards, calculate, timelines.

Resources: This year's calendar (find your own).

Date: _____ Week _____ Day _____

1 MENTAL MATHS (10 MINUTES)

	What time is?	Answer		What time is?	Answer
1	1 hour later than 12:00?	01:00	6	one hour earlier than twelve o'clock?	eleven o'clock
2	2 hours earlier than 11:00?	09:00	7	two hours later than five o'clock?	seven o'clock
3	1 hour before 02:00?	01:00	8	one hour after twelve o'clock?	one o'clock
4	2 hours after 04:00?	06:00	9	three hours before eleven o'clock?	eight o'clock
5	3 hours earlier than 08:00?	05:00	10	one hour later than nine o'clock?	ten o'clock

2 LESSON CONTENT – CONCEPT DEVELOPMENT (45 MINUTES)

This is the fourth time lesson. In this lesson learners work with calendars. They will read dates on a calendar. They will also place birthdays, religious festivals, public holidays, historical events and school events on a calendar. In the second activity, the learners will compare two different years' calendars and compare the difference in time.

Today we are learning to read calendars.

Activity 1: Whole class activity

- Give the learners a copy of **this year's** calendar and ask them to paste it in their mathematics books.
- Let them name and write the following on the calendar:
 - Their own birthday;
 - A friend's birthday;
 - School events (e.g. mathematics test days, school sports day).

Activity 2: Whole class activity

- Refer to the copy of the **2014** calendar in the Learner Activity.
- Let them name and write the following on the 2014 calendar (as above):
 - Their own birthday;
 - A friend's birthday;
 - School events (e.g. mathematics test days, school sports day).
- Ask the learners to compare the days on which the events they have written onto their calendars occur (this year's and 2014).
- Ask: **What do they notice?** (The days change – they are not the same each year.)

Activity 3: Learners work in pairs

- Learner will use their calendars to calculate and describe lengths of time in days or weeks or months.
- Write these questions on the board and read them to the class.
- Each time the learners should give the answers both as a number of days and a number of weeks and days:
 - **How long is it between your birthday and your partner's birthday?**
 - **How long is it between the first mathematics test and the second mathematics test this term?**
 - **How long is it between the first day of school and the school sports day?**
 - **How long is it between the school sports day and the last day of term?**
 - Other questions about school events that your class entered on the calendar.

3 CLASSWORK ACTIVITY AND CORRECTION OF HOMEWORK (25 MINUTES)

1 Colour the South African public and religious holidays on a 2019 calendar.

South African public holidays calendar	
New Year's Day	Tuesday 1 January
Human Rights Day	Thursday 21 March
Good Friday	Friday 19 April
Family Day	Monday 22 April
Freedom Day	Saturday 27 April
Workers' Day	Wednesday 1 May
Youth Day	Sunday 16 June
Women's Day	Friday 9 August
Heritage Day	Tuesday 24 September
Day of Reconciliation	Monday 16 December
Christmas Day	Wednesday 25 December
Day of Goodwill	Thursday 26 December

- 2** Colour the block of your favourite month in yellow. (Answers will vary.)
- 3** How long is it between New Year's Day and Freedom Day? (Answer both as a number of days and a number of weeks and days.)
- 4** How long is it between Youth Day and Heritage Day? (Answer both as a number of days and a number of weeks and days.)

4 HOMEWORK ACTIVITY (5 MINUTES)

- 1** Colour your family members' birthdays on the calendar you used for your classwork.
- 2** How many months of the year have no family birthdays? Name them. (This answer will differ from learner to learner.)
- 3** How long is it between your birthday and another person in your family's birthday? (Answer both as a number of days and a number of weeks and days.)

5 REFLECTION AND SUMMARY OF LESSON (5 MINUTES)

Call the whole class to attention and summarise the key concepts of the lesson.

Today we have learnt to read calendars.

Lesson 30: Consolidation

Teacher's notes

This lesson allows for consolidation of the previous days' lesson content.

CAPS topics: 4.1 Time.

Lesson Objective: To practise telling and calculating time.

Lesson Vocabulary: Analogue time, digital time, hour(s), half hour(s), quarter hour(s), minute(s), clock, o'clock, analogue clock, digital clock, am, pm, day(s), week(s), month(s), year(s), time, calendars, religious festivals, public holidays, historical events, weeks, months.

Resources: n/a.

Date:

Week

Day

1 NOTES FOR THE TEACHER RELATING TO THIS WEEK'S WORK

This week we have learnt about the concept of time. The learners have practised telling the time using analogue and digital clocks. They have solved problems that involve time passing as well as using calendars to measure time.

2 POSSIBLE MISCONCEPTIONS LINKED TO THE WEEK'S WORK

Learners often struggle with time. Elapsed/ the passing of time is a challenging concept for them. It is important that we use physical objects and pictorial representations of time so that the learners can experience time. While you provide opportunities for learners to practise time, encourage them to explain their understanding of the concepts. In this way, you are able to address the gaps in their knowledge.

3 CLASSWORK/HOMEWORK – COMPLETE THIS WEEK'S CLASSWORK AS NEEDED

Today we are going over what we learned this week. We are learning more about telling the time.

4 ADDITIONAL ACTIVITIES FOR CONSOLIDATION – SEE LEARNER RESOURCES

1 What is the time?

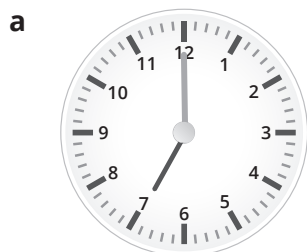

(7 o'clock)

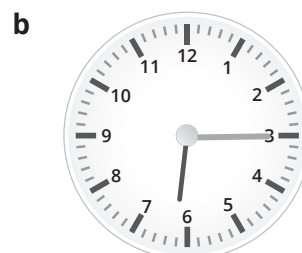

(quarter past six)

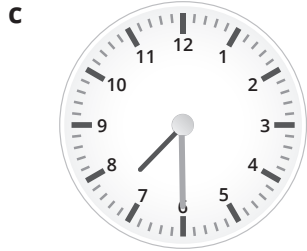

(half past seven)

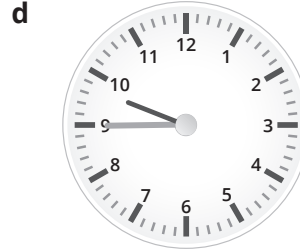

(quarter to 10)

- 2** Write as on a digital clock.
- a** Quarter past two. (02:15)
 - b** Quarter to nine. (08:45)
 - c** Half past nine. (09:30)
 - d** Seven o' clock. (07:00)
- 3** I left my home at seven this morning and arrived back from school at three o' clock. For how many hours did I leave my home? (8 hours)
- 4** Look at the calendar for this month. (Various answers to each question based on the month in which the exercise is done.)
- a** What month is it?
 - b** How many Thursdays are there in this month?
 - c** What is the date one week before the sixteenth of this month?
 - d** On what day is the last day of this month?
 - e** What will the date be one week after the twenty eighth of this month?

5 REFLECTION AND SUMMARY OF LESSON

Call the whole class to attention and summarise the key concepts of the lesson.

Today we have learnt to tell and measure time.

Week 7

Lesson 31: Assessment

Teacher's notes

This lesson should be used for assessment of the content covered in this unit to date.

CAPS topics: : 4.1 Time.

Resources: Printable assessment in teacher's resources.

Date: _____ Week _____ Day _____

1 SETTLE THE CLASS AND ADMINISTER THE ASSESSMENT. (45 MINUTES)

The assessment for today is linked to the work covered in the unit to date.

You will find the printable version of the assessment in the teacher's resource pack.

Take some time to do the *oral and practical assessment* (see rubric below).

2 DISCUSS ASSESSMENT ITEMS WITH THE CLASS (45 MINUTES)

Take in the learners' work when they are done.

There should be time for you to discuss a few of the items with the class:

- use this opportunity to reflect on different methods used by learners (allow some learners to write their solutions on the board).
- speak about misconceptions that may have arisen in learners' responses.

3 ASSESSMENT

WRITTEN ASSESSMENT (10 MARKS)

- 1 Write half past 7 in digital time. (1)
(7:30 or 19:30)
- 2 Write quarter to 9 in digital time. (1)
(8:45)
- 3 Circle the clock that shows quarter past two. (1)

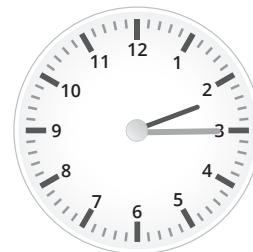
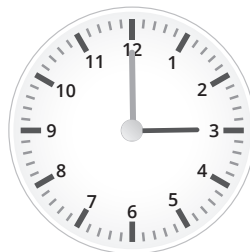

- 4 Draw the hands on this analogue clock to show half past 3 in the afternoon. (2)

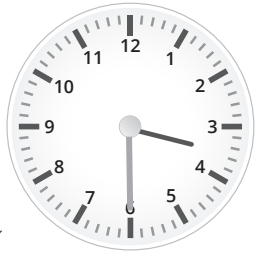

()

- 5 Show quarter to 10 on an analogue and a digital clock. (3)

a

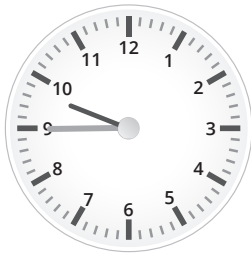

b

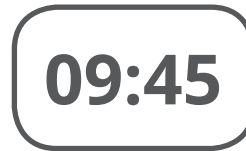

- 6 How much time passed between 2 o'clock and half past four in the afternoon? (2)
(Two and a half hours.)

ORAL AND PRACTICAL

CAPS: Measurement: Time		Mark: 7
Activity: Assess the learners' ability to tell 12-hour time in hours on analogue clocks.		
Mark	Criteria - rubric	
1	Unable to tell the time using an analogue clock	
2	Able to tell the time shown on an analogue clock with lots of assistance	
3	Able to tell and show the time shown on an analogue clock with lots of assistance	
4	Able to tell the time shown on an analogue clock with a little assistance	
5	Able to tell and show the time shown on an analogue clock with a little assistance	
6	Able to tell the time shown on an analogue clock with no assistance	
7	Able to tell and show the time shown on an analogue clock with no assistance	

Unit 4 Introduction

This unit focuses on 2-D shapes, symmetry and geometric patterns. *2-D shapes* are also called *two-dimensional shapes*, polygons or flat shapes. During this unit, the learners will explore the properties of the following 2-D shapes: circle, square, rectangle and triangle. A shape has a line of symmetry if the shape on one side of the line “mirrors” the shape on the other side. Symmetry can be seen in nature when looking at butterflies, flowers and leaves. In this unit, the learners identify and draw lines of symmetry using 2-D shapes. Lastly, geometric patterns are presented. A geometric pattern is an arrangement of *shapes*. *During these lessons, the learners will identify, describe and extend patterns.* The ability to recognize and create *patterns* helps learners make predictions based on their observations. Understanding *patterns* helps prepare learners for learning about more complex number concepts and mathematical operations. *Patterns* allow us to see relationships and develop generalisations.

Note that the mental maths activities in this unit allow consolidation of number concept, bonds and multiples. You could omit these if they restrict the time needed to do the more practical activities in the lessons.

In this unit you will be able to focus on the four framework dimensions in the following way:

- **Conceptual understanding:** This unit addresses the key concepts of 2-D shapes, symmetry and geometric patterns.
- **Procedural fluency:** Learners will develop procedural fluency in the ability to identify shapes and their properties, draw in lines of symmetry and identify, extend and describe geometric patterns.
- **Strategies:** Learners will discover how to work with the properties of 2-D shapes and symmetry and how to extend geometric patterns.
- **Reasoning:** Learners will be able to justify and explain relationships between shapes using the properties of 2-D shapes. They will also be able to reason when they explain how they worked out how to use rules they have identified to extend patterns.

Building a **learning centred classroom** in this unit will involve (amongst other things) attention to:

- **Active learning:** Learners are actively involved in the lessons in this unit as they are expected to identify and explore 2-D shapes, identify and draw lines of symmetry and identify, copy and extend geometric patterns.
- **Justifying answers:** Learners justify their answers by discussing the properties of 2-D shapes, symmetry and the rules of geometric patterns.
- **Speaking Mathematics:** Learners are encouraged to use the vocabulary of 2-D shapes, symmetry and geometric patterns when they speak about what they are doing – they should use all the vocabulary related to these concepts.

Lesson 32: Circles

Teacher's notes

This lesson is one of the fully planned lessons to be used to cover the Term 2 curriculum.

CAPS topics: 3.3 2-D shapes.

Lesson Objective: Describe, sort and compare circles.

Lesson Vocabulary: 2-D shapes, circle, square, straight, round, side(s), corner(s).

Resources: String and sticks.

Date:

Week

Day

1 MENTAL MATHS (10 MINUTES)

	Calculate the following:	Answer		Calculate the following:	Answer
1	$5 \times 10 =$	50	6	$3 \times 10 =$	30
2	$2 \times 10 =$	20	7	$10 \times 10 =$	100
3	$7 \times 10 =$	70	8	$0 \times 10 =$	0
4	$1 \times 10 =$	10	9	$6 \times 10 =$	60
5	$4 \times 10 =$	40	10	$8 \times 10 =$	80

2 LESSON CONTENT - CONCEPT DEVELOPMENT (45 MINUTES)

The next 6 lessons cover 2-D shapes. Each lesson focuses on a specific shape. In this lesson, we describe the circle and explore its features. A circle is round, and all points on the curved line are an equal distance from the centre point.

Today we are learning to describe, compare and draw circles. Circles are 2-D shapes because they are flat.

Activity 1: Whole class activity

- Describe a circle by saying, **I am thinking about a *shape*. It is round and has no straight sides. What shape am I thinking about?** (a circle)
- Ensure that you model the correct use of vocabulary.

Activity 2: Learners work in groups

- Take the learners outside to a place where the learners can draw in the sand.
- Let the learners get into groups of 5.
- What shape did we discuss in class?** (a circle)
- What are the features of a circle?** (It is round and has no straight sides.)

- Instruct the class:
- **In your groups find a stick.**
- **Each of you draw a different size circle in the sand.**
- Ask: **Who drew the biggest circle? Who drew the smallest circle?**
- Give each group a piece of string.
- **Using the string make a circle.**
- Which was easier to use to make a circle? A stick or string? Discuss this with your learners (no right answer here).
- Return to the classroom.

Activity 3: Whole class activity

- Draw a circle. Draw three more, but all of them should look different.
- Discuss with the class what is different about each one. (The differences could be in the size of the shapes. Circles do not look different if their 'orientation' is changed.)

3 CLASSWORK ACTIVITY AND CORRECTION OF HOMEWORK (25 MINUTES)

- 1 Draw 3 different sized circles in the table below. (Answers will vary)

Small circle	Bigger circle	Biggest circle

- 2 Draw circles in different positions in the table below. (Answers will vary)

Circle at the top	Circle in the middle	Circle at the bottom

- 3 Use 6 circles to create a picture. (Answers will vary)

4 HOMEWORK ACTIVITY (5 MINUTES)

Find and draw 3 objects that are circular in your home.

(Answers will vary e.g. clock, plates, bottle tops)

5 REFLECTION AND SUMMARY OF LESSON (5 MINUTES)

Call the whole class to attention and summarise the key concepts of the lesson.

Today we have learnt to describe, compare and draw circles.

Lesson 33: Triangles

Teacher's notes

This lesson is one of the fully planned lessons to be used to cover the Term 2 curriculum.

CAPS topics: 3.3 2-D shapes.

Lesson Objective: Describe, sort and compare triangles.

Lesson Vocabulary: 2-D shapes, triangle, straight, round, side(s), corner(s), length, size.

Resources: String and sticks, scrap paper, advertisement flyers (collect and bring from home).

Date:

Week

Day

1 MENTAL MATHS (10 MINUTES)

	Calculate the following:	Answer		Calculate the following:	Answer
1	$_ \times 10 = 50$	5	6	$_ \times 10 = 90$	9
2	$_ \times 10 = 30$	3	7	$_ \times 2 = 18$	9
3	$_ \times 2 = 12$	6	8	$_ \times 2 = 14$	7
4	$_ \times 2 = 20$	10	9	$_ \times 10 = 70$	7
5	$_ \times 10 = 60$	6	10	$_ \times 2 = 0$	0

2 LESSON CONTENT - CONCEPT DEVELOPMENT (45 MINUTES)

This is the second of six lessons on 2-D shapes. In this lesson, we focus on triangles. A triangle is a shape with 3 sides and 3 angles. Triangles are 2-D shapes because they are flat. Triangles have three straight sides which may differ in length. Refer to the bilingual dictionary for explanations and examples of terminology if necessary.

Today we are learning about the features of triangles.

Activity 1: Whole class activity

- Describe a triangle by saying, **I am thinking about a shape. It has 3 straight sides and 3 angles. What shape am I thinking about?** (a triangle)
- Ensure that you model the correct use of vocabulary.

Activity 2: Learners work in groups

- Take the learners outside to a place where the learners can draw in the sand.
- Let the learners get into groups of 5.
- What shape did we discuss in class?** (a triangle)
- What are the features of a triangle?** (It has 3 straight sides and 3 angles)

- Instruct the class:
- **In your groups find a stick.**
- **Each of you draw a different size triangle in the sand.**
- Ask: **Who drew the biggest triangle? Who drew the smallest triangle?**
- Give each group a piece of string.
- **Using the string make a triangle.** Encourage the learners to use the correct vocabulary.
- Which was easier to use to make a triangle? A stick or string? Discuss this with your learners (no right answers here).
- Return to the classroom.

Activity 3: Learners work in pairs

- Draw a triangle. Draw three more, but all of them should look different.
- Discuss with your partner what is different about each one. (The differences could be in the size and/or orientation of the shapes.)

3 CLASSWORK ACTIVITY AND CORRECTION OF HOMEWORK (25 MINUTES)

NOTE: Learners need to use scrap paper for question 1 of this activity.

- 1 Use 2 square pieces of paper. Fold each one twice to make a square and a triangle.
- 2 Stick them in your maths book and label them.
- 3 Work in pairs. How many shapes do you see? Count very carefully.

a

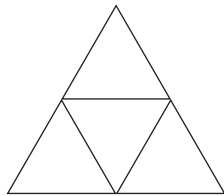

There are ____ triangles. (5)

b

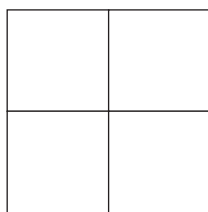

There are ____ squares. (5)

c

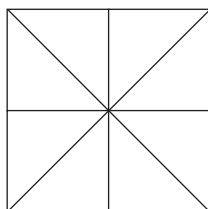

There are __ squares, __ triangles and __ rectangles.
(5, 16, 4 or 9 if the squares are counted as rectangles)

2 Draw five triangles. They must all look different.

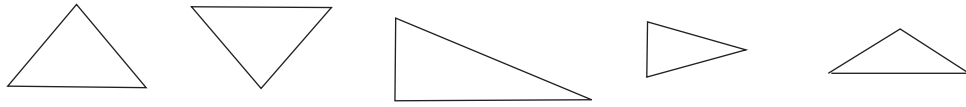

3 Find and cut triangles of different sizes from a magazine or newspaper. Stick them into your book, in different positions.

- a** How many sides does each triangle have? (3 sides)
- b** Are the sides straight or round? (straight)

4 HOMEWORK ACTIVITY (5 MINUTES)

How many triangles are there in this picture? (23)

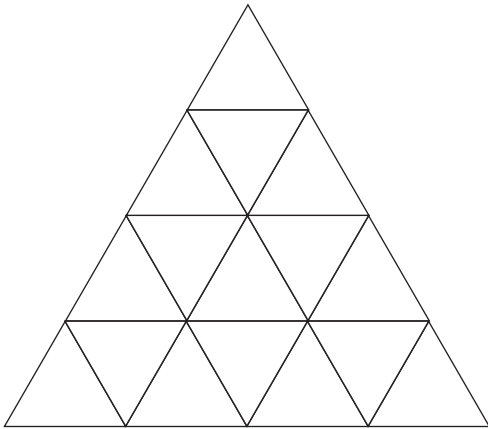

5 REFLECTION AND SUMMARY OF LESSON (5 MINUTES)

Call the whole class to attention and summarise the key concepts of the lesson.

Today we have learnt to draw, compare and discuss triangles.

Lesson 34: Squares

Teacher's notes

This lesson is one of the fully planned lessons to be used to cover the Term 2 curriculum.

CAPS topics: 3.3 2-D shapes.

Lesson Objective: Describe, sort and compare squares.

Lesson Vocabulary: 2-D shapes, square, straight, round, side(s), corner(s), length, size.

Resources: String and sticks.

Date:

Week

Day

1 MENTAL MATHS (10 MINUTES)

	Calculate the following:	Answer		Calculate the following:	Answer
1	$1 \times 1 =$	1	6	$3 \times 5 =$	15
2	$1 \times 2 =$	2	7	$3 \times 6 =$	18
3	$2 \times 2 =$	4	8	$4 \times 5 =$	20
4	$2 \times 3 =$	6	9	$5 \times 1 =$	5
5	$3 \times 4 =$	12	10	$10 \times 2 =$	20

2 LESSON CONTENT - CONCEPT DEVELOPMENT (45 MINUTES)

This is the third of six lessons on 2-D shapes. In this lesson, we focus on squares. A square is a flat shape with 4 sides equal in length and 4 equal angles. Squares are 2-D shapes because they only have length and width. Length is how long something is and width is how wide something is.

Today we are learning to describe and compare squares.

Activity 1: Whole class activity

- Describe a **square** by saying, **I am thinking about a shape.**
- **It has 4 sides and 4 corners. All the sides are the same length and all the corners are the same size. What shape am I thinking about?** (a square)
- Ensure that you model the correct use of vocabulary.

Activity 2: Learners work in groups

- Take the learners outside to a place where the learners can draw in the sand.
- Let the learners get into groups of 5.
- **What shape did we discuss in class?** (a square)

- **What are the features of a square?** (It has 4 equal sides and 4 corners)
- Instruct the class:
- **In your groups find a stick.**
- **Each of you draw a different size square in the sand.**
- **Ask: Who drew the biggest square? Who drew the smallest square?**
- Give each group a piece of string.
- **Using the string make a square.** Encourage the learners to use the correct vocabulary.
- Which was easier to use to make a square? A stick or string? Discuss this with your learners (no right answers here).
- Return to the classroom.

3 CLASSWORK ACTIVITY AND CORRECTION OF HOMEWORK (25 MINUTES)

- 1** Draw a square. Draw three more, but all should look different.
(Answers will vary. The differences could be in the size and/or orientation of the shapes.)
- 2** Draw a picture that is made up of 8 different sized squares.
- 3** Draw three squares:
 - a** A square with 4 cm sides.
 - b** A square with 7 cm sides.
 - c** A square with 10 cm sides.

4 HOMEWORK ACTIVITY (5 MINUTES)

Find and draw 3 objects that are square in your home.
(Answers will vary e.g. table, window, tile, side of a box.)

5 REFLECTION AND SUMMARY OF LESSON (5 MINUTES)

Call the whole class to attention and summarise the key concepts of the lesson.

Today we have learnt to describe and compare squares.

Lesson 35: Consolidation

Teacher's notes

This lesson allows for consolidation of the previous days' lesson content.

CAPS topics: 3.3 2-D shapes.

Lesson Objective: To revise the features of a square, circle and triangle.

Lesson Vocabulary: 2-D shapes, square, circle, triangle, straight, round, side(s), corner(s), length, size.

Resources: n/a.

Date:

Week

Day

1 NOTES FOR THE TEACHER RELATING TO THIS WEEK'S WORK

This week we have focused on 3 2-D shapes and their features. We have drawn the shapes in the sand and using string. In this way, the learners have actively engaged with shapes.

2 POSSIBLE MISCONCEPTIONS LINKED TO THE WEEK'S WORK

The learners may experience difficulties with speaking about the properties/features of a 2-D shape. A 2-D shape is flat. It is very important that you do not use 3-D objects to teach 2-D shape features as this may confuse the learners.

3 CLASSWORK/HOMEWORK - COMPLETE THIS WEEK'S CLASSWORK AS NEEDED

Today we are going over what we learned this week. We are learning more about 2-D shapes.

4 ADDITIONAL ACTIVITIES FOR CONSOLIDATION - SEE LEARNER RESOURCES

1 Complete the table:

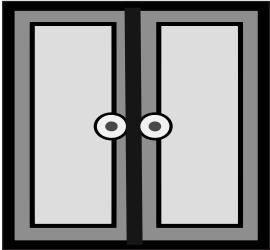
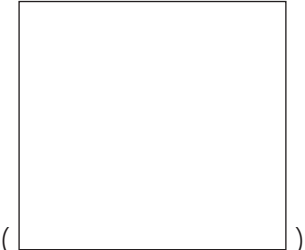
	Object	Drawing of shape	Name of shape
a			(square)

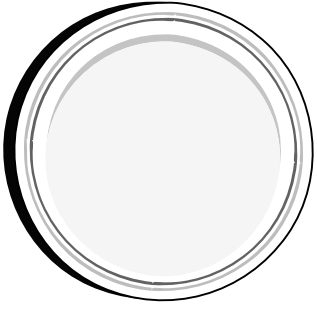
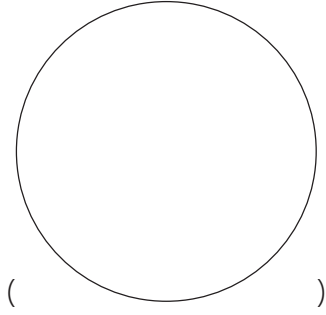
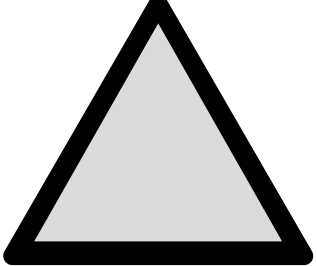
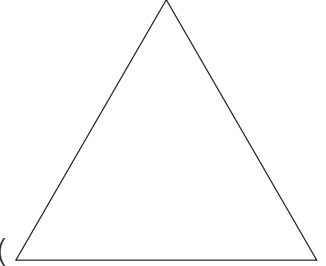
b			(circle)
c			(triangle)

- 2** Draw a car using triangles, circles and squares.
(Answers will vary)

5 REFLECTION AND SUMMARY OF LESSON

Call the whole class to attention and summarise the key concepts of the lesson.

Today we have learnt about the features of 2-D shapes.

Week 8

Lesson 36: Rectangles

Teacher's notes

This lesson is one of the fully planned lessons to be used to cover the Term 2 curriculum.

CAPS topics: 3.3 2-D shapes.

Lesson Objective: Describe and compare rectangles.

Lesson Vocabulary: 2-D shapes, rectangle, straight, round, side(s), corner(s), length, size.

Resources: String and sticks.

Date: _____ Week _____ Day _____

1 MENTAL MATHS (10 MINUTES)

	Calculate the following:	Answer		Calculate the following:	Answer
1	$4 \times 2 =$	8	6	$1 \times 20 =$	20
2	$3 \times 2 =$	6	7	$5 \times 4 =$	20
3	$5 \times 2 =$	10	8	$6 \times 3 =$	18
4	$6 \times 2 =$	12	9	$10 \times 2 =$	20
5	$7 \times 2 =$	14	10	$5 \times 3 =$	15

2 LESSON CONTENT - CONCEPT DEVELOPMENT (45 MINUTES)

This is the fourth of six lessons on 2-D shapes. In this lesson, we focus on rectangles. A *rectangle* is a four-sided shape with four square corners and four straight sides. Rectangles are 2-D shapes because they are flat.

Today we are learning about the features of a rectangle.

Activity 1: Whole class activity

- Describe a rectangle by saying, **I am thinking about a shape.**
- **It has 4 sides and 4 square corners. The opposite pairs of sides are the same length.**
What shape am I thinking about? (a rectangle)
- Ensure that you model the correct use of vocabulary.

Activity 2: Learners work in groups

- Take the learners outside to a place where the learners can draw in the sand.
- Let the learners get into groups of 5.
- **What shape did we discuss in class?** (a rectangle)
- **What are the features of a rectangle?** (It has 4 sides, 4 square corners and the opposite pairs of sides are equal in length.)
- Instruct the class:
- **In your groups, find a stick.**
- **Each of you draw a different size rectangle in the sand.**
- Ask: **Who drew the biggest rectangle? Who drew the smallest rectangle?**
- Give each group a piece of string.
- **Using the string make a rectangle.** Encourage the learners to use the correct vocabulary.
- Which was easier to use to make a rectangle? A stick or string? Discuss this with your learners (no right answers here).
- Return to the classroom.

Activity 3: Whole class activity

- Encourage learners to learn and use all of the shape names you have used in the last 4 lessons on shapes, circle, triangle, square and rectangle. Ask learners to look around the classroom.
- Ask: **Give the names of objects in the class that are rectangular in shape.** (Window, desk, pencil case, eraser, book, carpet, etc.)
- Discuss the difference between the outline of the shape (e.g. the outline of a window frame that looks rectangular) and the solid 3-D window frame itself. The window frame is not a rectangle but it has a rectangular shape.
- Ask: **Give the names of objects in the class that are circular, triangular and square in shape.** (Examples will vary depending on what learners see in the class. Windows could be square/rectangular, the dustbin could have a circular opening, a bottle or can has a circular edge, triangles are more difficult to find – you might have a triangular box? etc.)
- Ask: **What do all these shapes have in common?** (They are all 2-D shapes)

3 CLASSWORK ACTIVITY AND CORRECTION OF HOMEWORK (25 MINUTES)

Draw the following:

- 1 A rectangle 5 cm wide and 7 cm long in the middle of your page.
- 2 Draw a triangle on the left of the rectangle.
- 3 Draw a 4 cm square on the right of the rectangle.
- 4 Draw circle below the rectangle.

Solution:

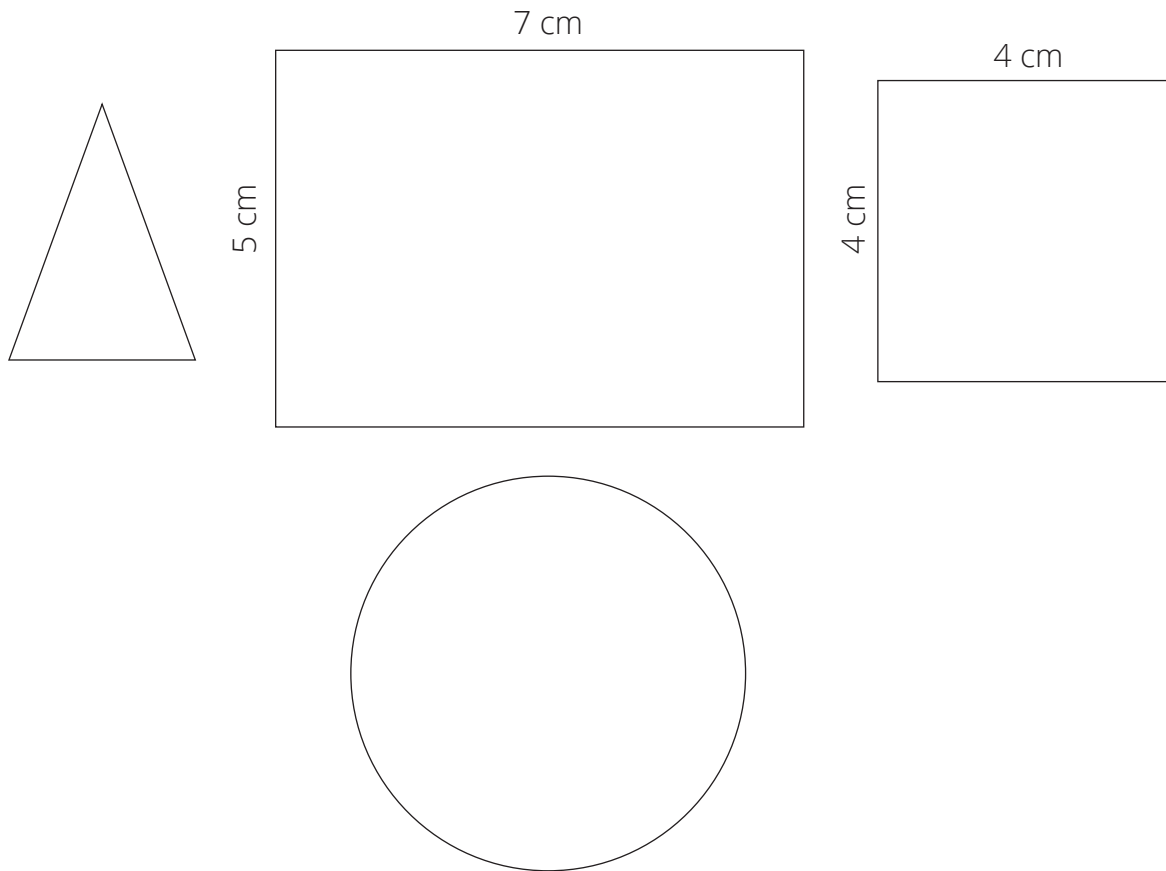

4 HOMEWORK ACTIVITY (5 MINUTES)

Draw a picture of a person using rectangles, squares, circles and triangles.
(Answers will vary)

5 REFLECTION AND SUMMARY OF LESSON (5 MINUTES)

Call the whole class to attention and summarise the key concepts of the lesson.

Today we have learnt about the characteristics of a rectangle.

Lesson 37: Assessment

Teacher's notes

This lesson should be used for assessment of the content covered in this unit to date.

CAPS topics: 3.3 2-D shapes.

Resources: Printable assessment in teacher's resources.

Date:

Week

Day

1 SETTLE THE CLASS AND ADMINISTER THE ASSESSMENT. (45 MINUTES)

The assessment for today is linked to the work covered in the unit to date.

You will find the printable version of the assessment in the teacher's resource pack.

2 DISCUSS ASSESSMENT ITEMS WITH THE CLASS (45 MINUTES)

Take in the learners' work when they are done.

There should be time for you to discuss a few of the items with the class:

- use this opportunity to reflect on different methods used by learners (allow some learners to write their solutions on the board).
- speak about misconceptions that may have arisen in learners' responses.

3 ASSESSMENT

WRITTEN ASSESSMENT (12 MARKS)

- 1 Circle which of these shapes have round sides. (1)

Square, circle, rectangle, triangle

- 2 Draw 3 different size triangles in 3 different positions. (3)

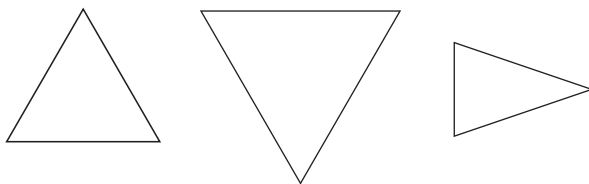

- 3** Draw a square that has 5 cm sides. (3)

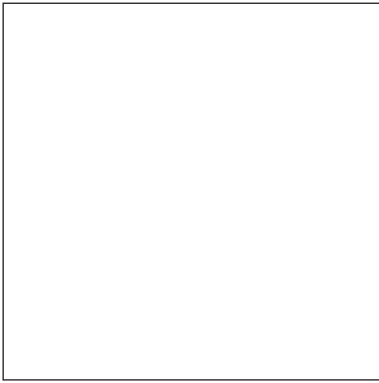

- 4** Draw a rectangle that is 6 cm long and 4 cm wide. (4)

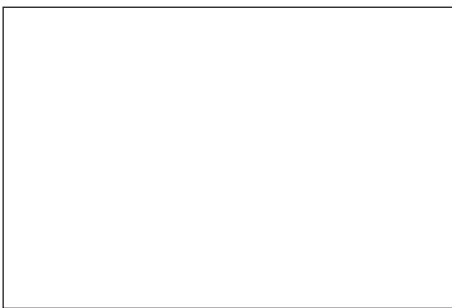

- 5** A square, triangle, circle and rectangle are 2-D shapes. What does this mean? (1)
(It means that they are flat.)

Lesson 38: Sort and Compare 2-D shapes

Teacher's notes

This lesson is one of the fully planned lessons to be used to cover the Term 2 curriculum.

CAPS topics: 3.3 2-D shapes.

Lesson Objective: To sort and compare 2-D shapes.

Lesson Vocabulary: 2-D shapes, square, circle, triangle, rectangle, straight, round, side(s), corner(s), length, size.

Resources: Shape cut outs (1) and shape names (see *Printable Resources*), scrap paper, coloured pencils.

Date:

Week

Day

1 MENTAL MATHS (10 MINUTES)

	Calculate the following:	Answer		Calculate the following:	Answer
1	$1 \times 1 =$	1	6	$3 \times 4 =$	12
2	$4 \times 5 =$	20	7	$2 \times 1 =$	2
3	$5 \times 2 =$	10	8	$8 \times 0 =$	0
4	$3 \times 1 =$	3	9	$9 \times 10 =$	90
5	$7 \times 3 =$	21	10	$6 \times 5 =$	30

2 LESSON CONTENT - CONCEPT DEVELOPMENT (45 MINUTES)

This is the last lesson on 2-D shapes. The learners will sort and compare 2-D shapes. They will compare shapes according to their shape and whether they have straight or round sides.

Today we are learning to sort and compare 2-D shapes.

Activity 1: Whole class activity



- Use Prestik to stick cut-outs of the following shapes on the board: rectangle, triangle, circle, square.
- Get the learners to identify the labels that belong to the cut-outs of the shapes and place them below the correct shapes.
- Point to one shape e.g. the rectangle, and ask the learners to each contribute one sentence towards describing the shape, e.g. It has 4 sides/All the sides are straight/There are 4 corners/All the corners are the same size, etc.
- Do the same for the remaining shapes.
- Try to ensure that everyone gets a chance to say something using the correct vocabulary.

Activity 2: Learners work in groups

- Give each group a sheet of scrap paper to draw on.
- Ask learners to draw as many shapes as they can think of with straight sides on the paper.
- Every learner in the group should get a chance to draw a shape.
- Compare each group's shapes to see if there are any other shapes that they didn't think of and add those shapes to your group's picture.
- Give each group a turn to call out one shape and a colour. The whole class now colours that shape (e.g. triangles – red). If a group does not have the shape, they draw it in.
- Carry on until all the shapes are coloured in.

Activity 3: Whole class activity

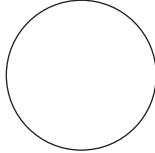
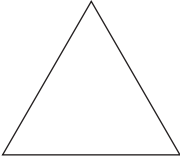
- Revise by asking: **If a shape does not have straight sides, what will it have?** (round sides)
- Draw the following shapes on the board, and ask learners to identify the number of straight and round sides on each one.

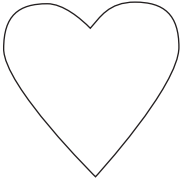
Drawing of shape	Number of round and straight sides
	One round side
	Three straight sides
	Four straight sides
	two round and two straight sides

3 CLASSWORK ACTIVITY AND CORRECTION OF HOMEWORK (25 MINUTES)

1 Say if the following shapes have round or straight sides:

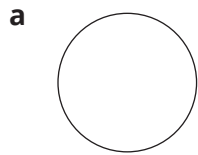

(round)

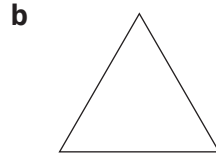

(straight)

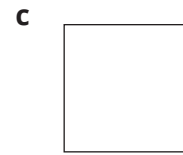

(straight)

2 Draw three shapes in each block below:

(Learners answers will vary.)

Shapes with straight sides	Shapes with round sides	Shapes with straight and round sides
(answers will vary – they may draw triangles, squares rectangles or other straight sided shapes.)	(answers will vary – any circular/round shapes.)	(answers will vary – creative shapes – learners draw things that are made up of straight and rounded sides, such as the heart in the classwork activity.)

4 HOMEWORK ACTIVITY (5 MINUTES)

Draw a picture of a house. Use circles, squares, rectangles and triangles. (Learner answers will vary.)

5 REFLECTION AND SUMMARY OF LESSON (5 MINUTES)

Call the whole class to attention and summarise the key concepts of the lesson.

Today we have learnt to sort and compare 2-D shapes.

Lesson 39: Consolidation of 2-D shapes

Teacher's notes

This lesson is one of the fully planned lessons to be used to cover the Term 2 curriculum.

CAPS topics: 3.3 2-D shapes.

Lesson Objective: To revise features of 2-D shapes in terms of size, colour, shape, straight sides, round sides.

Lesson Vocabulary: Estimate, check, 2-D shapes, straight sides, round/curved sides, describe, compare, rotate.

Resources: Shape cut outs (2) and shape names (see *Printable Resources*).

Date: _____ Week _____ Day _____

1 MENTAL MATHS (10 MINUTES)

	Calculate the following:	Answer		Calculate the following:	Answer
1	$_ \times 10 = 50$	5	6	$_ \times 10 = 90$	9
2	$_ \times 10 = 30$	3	7	$_ \times 2 = 18$	9
3	$_ \times 2 = 12$	6	8	$_ \times 2 = 14$	7
4	$_ \times 2 = 20$	10	9	$_ \times 10 = 70$	7
5	$_ \times 10 = 60$	6	10	$_ \times 2 = 0$	0

2 LESSON CONTENT - CONCEPT DEVELOPMENT (45 MINUTES)

This lesson is on 2-D shapes. It provides the learners with an opportunity to consolidate their understanding of 2-D shapes and their properties.

Today we are revising 2-D shapes and their properties.

Activity 1: Whole class activity

- Revise curved and straight sides by asking learners to draw different 2-D shapes on the board.
- Each time, ask the learner to name the shape they drew and discuss its properties (straight/round sides, big/small).
- Use the shape name cards to label the drawings the learners do.

Activity 2: Whole class activity

Stick cardboard cut-out shapes (rectangles, squares and triangles) randomly on the board.

- Ask: **What can you tell me about the sides of all these shapes?** (They are all straight.)



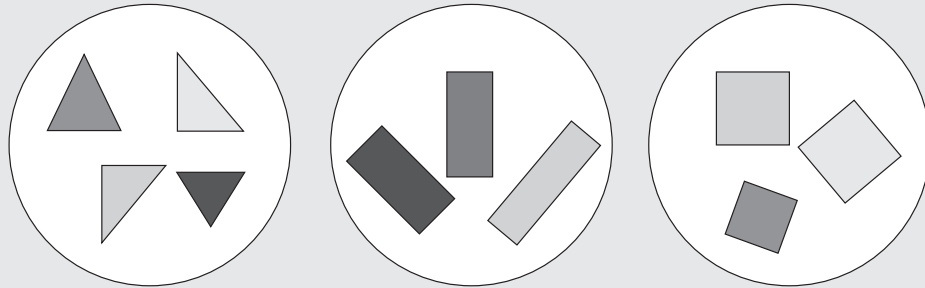

- Ask: **What shapes are they?** (Triangles, rectangles, squares.)
- Call a learner to sort the shapes on the board.
- Ask: **How did you sort the shapes** (We put all the rectangles together, all the triangles together and all the, squares together.)

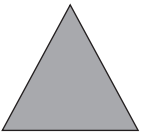
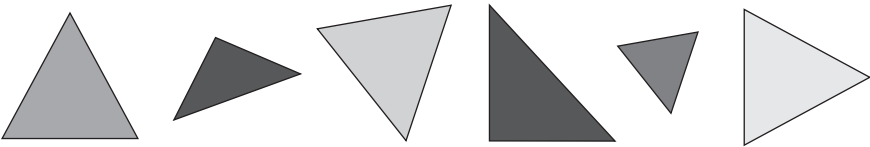

- Rotate the shapes so that they all face different directions.
- Ask: **Are the shapes in the circle still triangles?** (Yes.)
 - Ask: **How do you know?** (Triangles have three straight sides and three corners. If you rotate a shape it changes position but the shape itself does not change.) Do the same with the rectangles and squares.

Activity 3: Whole class activity

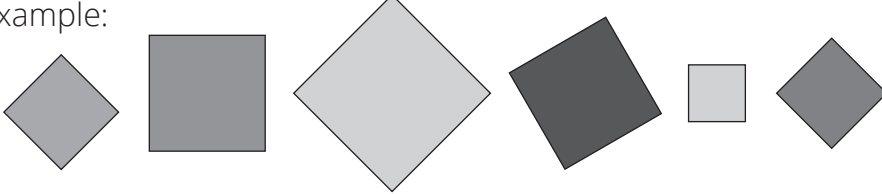
Draw the following on the board. Ask learners to come to the board and draw other shapes, e.g. triangles that look different from yours/are facing in a different direction. Ask them to explain what the difference is.

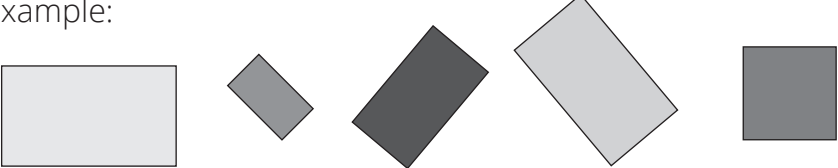
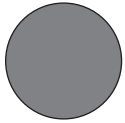
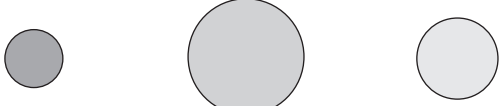
 triangle	Example: 
 square	Example: 
 rectangle	Example: 
 circle	Example: 

- **Note:** Help learners to become familiar with the shape terminology by asking questions and allowing learners to use the words they have learnt.

3 CLASSWORK ACTIVITY AND CORRECTION OF HOMEWORK (25 MINUTES)

NOTE: Learners need to use old newspapers/magazines/advertisement flyers for question 7 of the classwork activity. (Answers will vary)

- 1 Draw a triangle. Draw three more triangles, but in different positions.
- 2 Are the sides of the triangle round or straight? (Straight)
- 3 Draw a rectangle. Draw three more rectangles, but in different positions.
- 4 Are the sides of the rectangle round or straight? (Straight)
- 5 Draw three circles of different size.
- 6 Are the sides of the circle round or straight? (Round)
- 7 Find and cut out squares of different sizes from a magazine. Stick them in your book, all in different positions.
 - a How many sides does each one have? (3)
 - b Are they straight or round? (Straight)

4 HOMEWORK ACTIVITY (5 MINUTES)

Draw a picture of a tree. You may use shapes with straight sides and round sides. (Answers will vary)

5 REFLECTION AND SUMMARY OF LESSON (5 MINUTES)

Call the whole class to attention and summarise the key concepts of the lesson.

Today we have revised the properties of 2-D shapes.

Lesson 40: Consolidation

Teacher's notes

This lesson allows for consolidation of the previous days' lesson content.

CAPS topics: 3.3 2-D shapes.

Lesson Objective: To revise 2-D shapes.

Lesson Vocabulary: Estimate, check, 2-D shapes, straight sides, round/curved sides, describe, compare, rotate, size.

Resources: n/a.

Date:	Week	Day
-------	------	-----

1 NOTES FOR THE TEACHER RELATING TO THIS WEEK'S WORK

This week we have focused on 2-D shapes and their properties. The properties we have covered are size, colour, shape and sides.

2 POSSIBLE MISCONCEPTIONS LINKED TO THE WEEK'S WORK









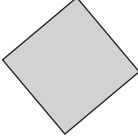

The learners may experience difficulties identifying the properties of a 2-D shape. They may struggle with the rotation of shapes and understanding that changing the position of a shape does not change the shape. You can address this misconception by using cut out shapes and encouraging the learners to move the shapes around and explore their properties.

3 CLASSWORK/HOMEWORK – COMPLETE THIS WEEK'S CLASSWORK AS NEEDED

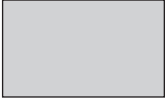
Today we are going over what we learned this week. We are learning more about 2-D shapes.

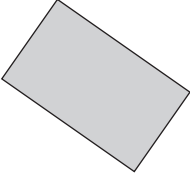
4 ADDITIONAL ACTIVITIES FOR CONSOLIDATION – SEE LEARNER RESOURCES

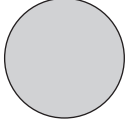
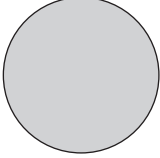
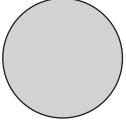
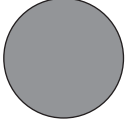
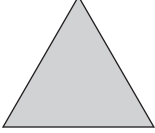
Complete the following table: (Answers will vary – the first column only will be given in the Learner Activity Book.)

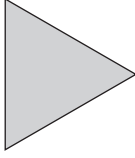
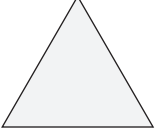
Shape	Different size	Different Position	Different colour
			
			
			
			

5 REFLECTION AND SUMMARY OF LESSON

Call the whole class to attention and summarise the key concepts of the lesson.

Today we have learnt about the properties of 2-D shapes.

Week 9

Lesson 41: Symmetry Part 1

Teacher's notes

This lesson is one of the fully planned lessons to be used to cover the Term 2 curriculum.

CAPS topics: 3.4 Symmetry.

Lesson Objective: To recognise and draw line of symmetry in 2-D geometrical and non-geometrical shapes.

Lesson Vocabulary: Forwards, backwards, symmetry, 2-D, geometrical, non-geometrical shapes, vertical line, horizontal line, diagonal line, predict, recognise, line of symmetry, symmetrical shape, whole, half, square, rectangle.

Resources: Scrap paper cut into squares and rectangles.

Date:

Week

Day

1 MENTAL MATHS (10 MINUTES)

	Calculate the following:	Answer		Calculate the following:	Answer
1	$_ \times 10 = 60$	6	6	$_ \times 10 = 70$	7
2	$_ \times 10 = 40$	4	7	$_ \times 2 = 18$	9
3	$_ \times 2 = 10$	5	8	$_ \times 2 = 20$	10
4	$_ \times 2 = 44$	22	9	$_ \times 10 = 100$	10
5	$_ \times 100 = 600$	6	10	$_ \times 100 = 0$	0

2 LESSON CONTENT - CONCEPT DEVELOPMENT (45 MINUTES)

There are two lessons on symmetry to consolidate learners' knowledge and understanding of the concept of symmetry. Paper folding is a very valuable activity when looking for lines of symmetry. Mirrors are useful, but you might not have enough for all of the learners. You should definitely allow learners to do the paper folding using scrap paper – remember to prepare enough square pieces of paper for each group.

Today we are learning to find and draw in lines of symmetry with 2-D shapes.

Activity 1: Learners work in groups

- Give each group of learners a paper square cut out of scrap paper.
- Ask the learners to fold the paper square to show the line of symmetry, using a vertical line.

- Unfold and trace over the fold with a red pencil.
- Use the same square, but use a horizontal line to show the line of symmetry. Trace the fold with a blue pencil.
- Ask the learners **is there another line of symmetry that you can fold?** (Yes, diagonal.)
- Draw the line using a green pencil.
- Ask the learners **is there another line of symmetry that you can fold?** (Yes, another diagonal.)
- Draw the line using a purple pencil.
- Ask the learners **is there another line of symmetry that you can fold?** (No.)
- **How many lines of symmetry altogether?** (Four.)

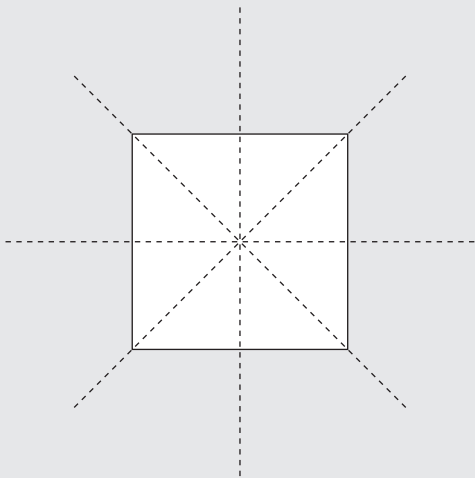

Activity 2: Learners work in groups

- Repeat the steps above with a rectangle cut out of scrap paper. (You will find two lines of symmetry.)
- Encourage the learners to investigate if the diagonals of the rectangle are lines of symmetry – this will show them concretely that the rectangle only has two lines of symmetry.

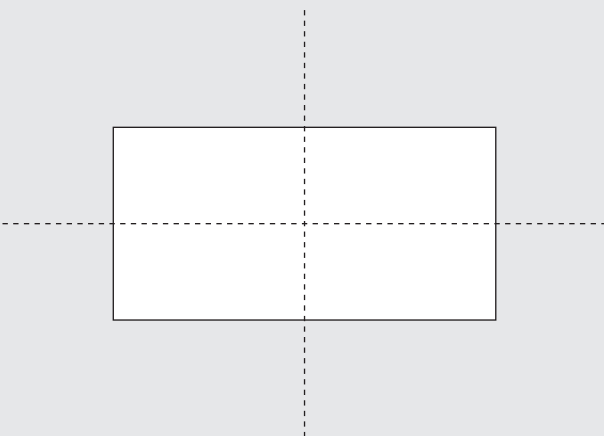

3 CLASSWORK ACTIVITY AND CORRECTION OF HOMEWORK (25 MINUTES)

NOTE: Explain to the learners that predicting the lines of symmetry is important. They should try to predict before they use paper folding to find the lines of symmetry. *Explain the activity to the class before they begin.*

For each shape in the table learners must:

- 1 Predict the number and draw the lines of symmetry. Write these answers in the 'We predict' column.
- 2 Cut out the shape and fold it to find all the lines of symmetry. Draw and write your answers in the 'We found' column.
- 3 When you have completed the worksheet discuss with another pair what you predicted and what you found.

Complete the table:

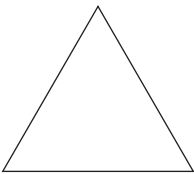
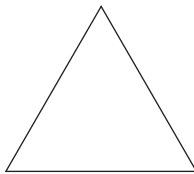
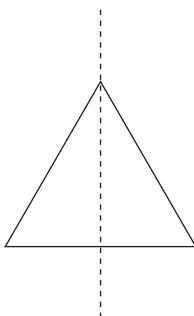
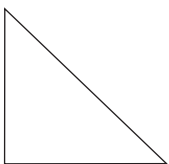
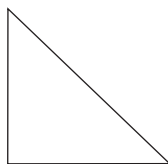
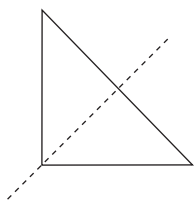
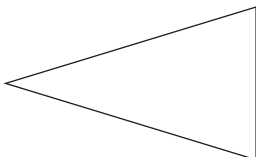
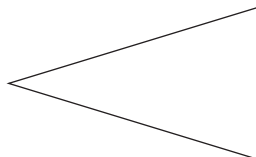
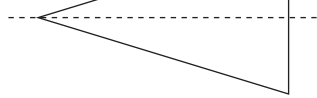
Shape	Lines of symmetry	
	We predict (Answers will vary)	We found
		(One line of symmetry - vertical.) 
		(One line of symmetry - oblique.) 
		(One line of symmetry - horizontal.) 

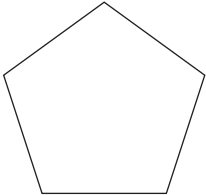
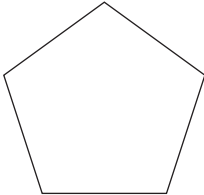
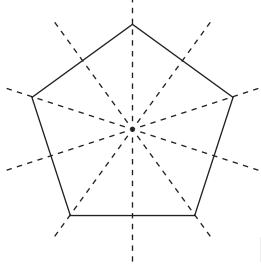
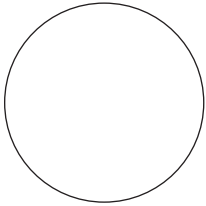
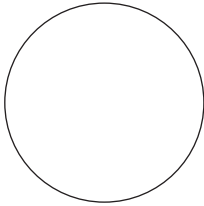
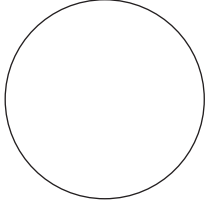
Shape	Lines of symmetry	
	We predict (Answers will vary)	We found
		<p>(Five lines of symmetry – one from each vertex to the centre of the opposite side.)</p> 
		<p>(An infinite number of lines of symmetry – any line through the centre of the circle.)</p> 

4 HOMEWORK ACTIVITY (5 MINUTES)

- 1 Draw a square.
- 2 Draw a design inside the square so that the square is still symmetrical. (Answers will vary.)

5 REFLECTION AND SUMMARY OF LESSON (5 MINUTES)

Call the whole class to attention and summarise the key concepts of the lesson.

Today we have found and drawn in lines of symmetry in 2-D shapes.

Lesson 42: Symmetry Part 2

Teacher's notes

This lesson is one of the fully planned lessons to be used to cover the Term 2 curriculum.

CAPS topics: 3.4 Symmetry.

Lesson Objective: To identify and draw lines of symmetry in 2-D geometrical and non-geometrical shapes.

Lesson Vocabulary: Forwards, backwards, line of symmetry, horizontal, vertical, geometric shapes, non-geometric shapes, symmetry, symmetrical shape, infinite, whole, half, circle, square, rectangle, triangle.

Resources: One large cut-out paper circle, square, rectangle and triangle (for demonstration).

Date:

Week

Day

1 MENTAL MATHS (10 MINUTES)

	Calculate the following:	Answer		Calculate the following:	Answer
1	$_ \times 5 = 55$	11	6	$8 \times 4 = _$	32
2	$_ \times 10 = 40$	4	7	$_ \times 5 = 45$	9
3	$6 \times 2 = _$	12	8	$_ \times 4 = 24$	6
4	$_ \times 4 = 40$	10	9	$6 \times 5 = _$	30
5	$_ \times 10 = 60$	6	10	$6 \times 6 = _$	36

2 LESSON CONTENT - CONCEPT DEVELOPMENT (45 MINUTES)

This is the second lesson on symmetry. As discussed in the previous lesson it is important that the learners are actively involved in the activities in order to understand the concept of symmetry.

Today we are learning more about finding lines of symmetry in 2-D shapes.

Activity 1: Whole class activity

- You need a large cut-out circle for this activity – for demonstration purposes.
- Show learners a large circle and explain that you are going to fold it to find the line of symmetry.
- Fold the circle perfectly in half, so that the fold will be in the place of a line of symmetry for the circle.
- Ask: **What will the shape look like when you open it up?**
- Ask: **How would you do a drawing of the shape with its line of symmetry?**
- Unfold the circle and examine the fold line that represents a line of symmetry.

- Once you have worked with the concrete shape, do the drawings.
- On the drawings mark the lines of symmetry.

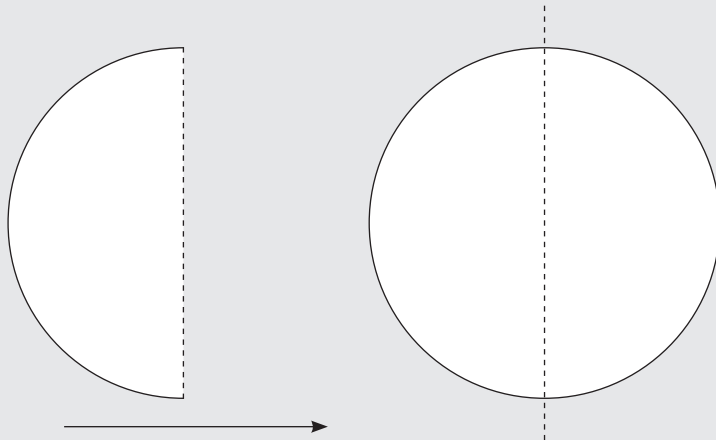

- On the board draw a picture of the folded shape and the unfolded shape with the line of symmetry in its place.
- Ask: **Could I fold the shape in another place to find a different line of symmetry?** (Yes, I could fold it many ways and find a line of symmetry. Demonstrate.)

Activity 2: Whole class activity

- Repeat the sequence of steps above using other shapes – to demonstrate finding lines of symmetry. Allow learners to come to the front and participate in the demonstration if possible.
- Ask the learners to predict what it will look like when you open the shape up, i.e. **What do you think this shape will look like if you drew it with its line of symmetry?**
- Each time, show the original shape first, then show it folded, then unfold it and examine the fold line that represents a line of symmetry.
- Once you have worked with the concrete shape, do the drawings.
- On the drawings mark the lines of symmetry.
- Do all of these steps with the shapes below. Interact with the learners while you do this, allowing them to predict the fold lines/lines of symmetry. Allow some learners to come and do the drawings on the board if time allows.
 - Square (4 lines of symmetry)
 - Rectangle (2 lines of symmetry)
 - Triangle (Various lines of symmetry, depending on the triangle)
 - Circle (MANY lines of symmetry – an infinite number)

3 CLASSWORK ACTIVITY AND CORRECTION OF HOMEWORK (25 MINUTES)

Draw the lines of symmetry into the following shapes:

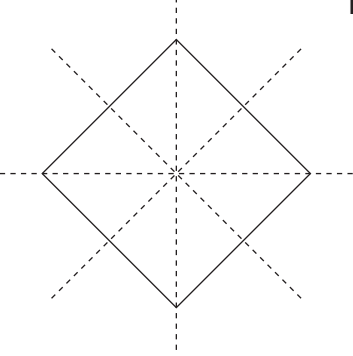
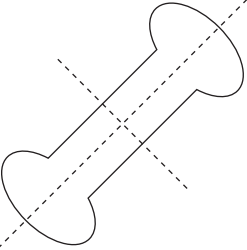
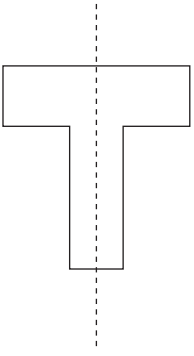
a  **b**  **c** 

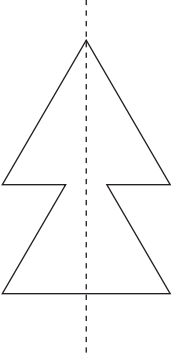
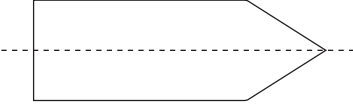
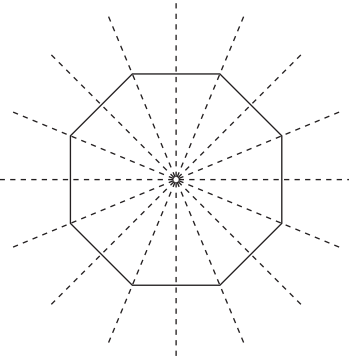
d  **e**  **f** 

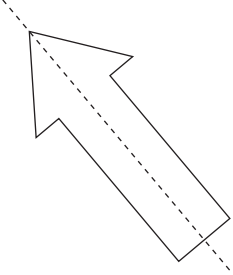
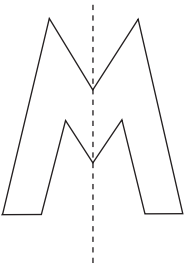
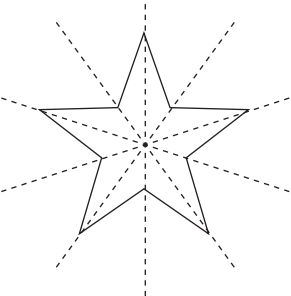
g  **h**  **i** 

4 HOMEWORK ACTIVITY (5 MINUTES)

1 Draw a symmetrical pattern in this grid. (Answers will vary.)

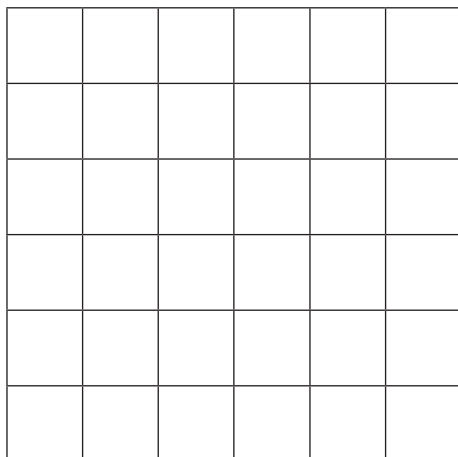

2 How many lines of symmetry in your pattern? (Answers will vary.)

5 REFLECTION AND SUMMARY OF LESSON (5 MINUTES)

Call the whole class to attention and summarise the key concepts of the lesson.

Today we have learnt to find lines of symmetry in 2-D shapes.

Lesson 43: Assessment

Teacher's notes

This lesson should be used for assessment of the content covered in this unit to date.

CAPS topics: 3.3 2-D shapes, 3.4 Symmetry.

Resources: Printable assessment in teacher's resources.

Date:

Week

Day

1 SETTLE THE CLASS AND ADMINISTER THE ASSESSMENT. (45 MINUTES)

The assessment for today is linked to the work covered in the unit to date.

You will find the printable version of the assessment in the teacher's resource pack.

Take some time to do the *oral and practical assessment* (see rubric below).

2 DISCUSS ASSESSMENT ITEMS WITH THE CLASS (45 MINUTES)

Take in the learners' work when they are done.



There should be time for you to discuss a few of the items with the class:

- use this opportunity to reflect on different methods used by learners (allow some learners to write their solutions on the board).
- speak about misconceptions that may have arisen in learners' responses.

3 ASSESSMENT

WRITTEN ASSESSMENT (17 MARKS)

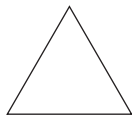
- 1 Complete this table. (12)

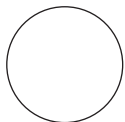
	Name of shape	Number of sides	Round/straight?
a 	(square)	(4)	(straight)
b 	(triangle)	(3)	(straight)
c 	(rectangle)	(4)	(straight)
d 	(circle)	(1)	(round)

(1 mark for each correct answer)

2 Draw 3 triangles. Each one must look different. (3)

(Answers will vary)

3 Draw the line of symmetry into the shape below: (1)

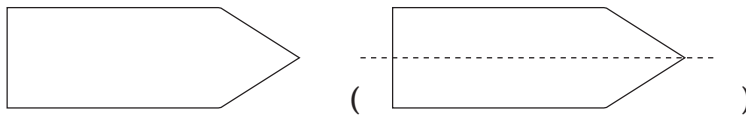

4 Draw the line of symmetry in the triangle. (1)

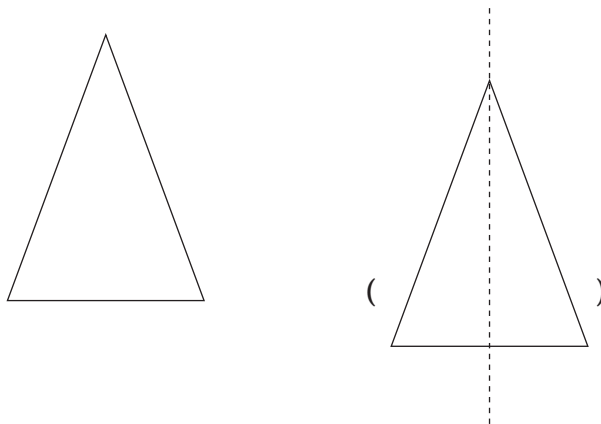

ORAL AND PRACTICAL

CAPS: Space and shape		Mark: 7
Activity: Assess the learners' ability to recognise and work with symmetry.		
Mark	Criteria - rubric	
1	Unable to recognise when a shape is symmetrical	
2	Able to recognise when a shape is symmetrical but cannot show the line of symmetry	
3	Able to recognise when a shape is symmetrical and show one line of symmetry	
4	Able to recognise when a shape is symmetrical and can show more than one line of symmetry	
5	Able to draw a symmetrical shape with one line of symmetry	
6	Able to draw a symmetrical shape with more than one line of symmetry	
7	Able to draw a symmetrical shape or pattern and describe symmetry in patterns where more than one symmetrical shape is present	

Lesson 44: Geometric patterns

Teacher's notes

This lesson is one of the fully planned lessons to be used to cover the Term 2 curriculum.

CAPS topics: 2.1 Geometric patterns.

Lesson Objective: To describe, create and extend geometric patterns.

Lesson Vocabulary: Geometric patterns, sequences, repeat, repetitive, copy, extend, describe, line(s), shape(s), object(s), circle, triangle, rectangle, square, pattern.

Resources: Shape cut outs (2) (see *Printable Resources*).

Date:

Week

Day

1 MENTAL MATHS (10 MINUTES)

	Calculate the following:	Answer		Calculate the following:	Answer
1	$2 \times 6 =$	12	6	$2 \times 7 =$	14
2	$3 \times 6 =$	18	7	$3 \times 7 =$	21
3	$4 \times 6 =$	24	8	$4 \times 7 =$	28
4	$5 \times 6 =$	30	9	$5 \times 7 =$	35
5	$10 \times 6 =$	60	10	$10 \times 7 =$	70

2 LESSON CONTENT - CONCEPT DEVELOPMENT (45 MINUTES)

Geometric patterns are different from number patterns because they involve shapes. But they are related to number patterns because to see the rule for a geometric pattern you usually need to use counting in some way. There are 4 geometric pattern lessons. In this first lesson the learners describe, create and extend geometric patterns.

Today we are learning to describe, create and extend geometric patterns.

Activity 1: Learners work in group

- In this activity, learners will create and describe patterns.
- Give each group a copy of the shape cut outs (2) so that they can cut out the shapes to use in this activity (each group will make 4 triangles, 4 squares, 4 rectangles and 4 circles).
- Learners take turns to place these shapes in repetitive patterns using 2 or more shapes in each pattern. e.g.



- After the learner has created the pattern, they should describe it to the group. The description should be as clear as possible using the characteristics of the items to explain the progression.
- The whole group copies the pattern onto their whiteboards/scrap paper.

Activity 2: Whole class activity

- In this activity learners will extend patterns
- Draw the following pattern on the board:

- Ask: **What is the next shape in the pattern?** (circle)
- **How do you know?** (Because the pattern goes circle, circle, triangle. After the first circle we need another one.)
- Invite a learner to draw the shape in the correct place on the board.
- Ask: **What comes after the circle?** (triangle)
- Invite a learner to draw the shape in the correct place on the board.
- Ask: **Who can give us the next two shapes?** (circle, circle)
- Again invite a learner to draw the shape in the correct place on the board.
- Now draw each of the following patterns on the board and, through questioning and interacting get the learners to complete the patterns by drawing at least three more items on the board.
- Draw other patterns if you prefer and allow learners to draw patterns which they make up themselves.

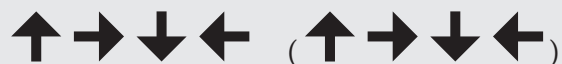

3 CLASSWORK ACTIVITY AND CORRECTION OF HOMEWORK (25 MINUTES)

Copy and extend these patterns.

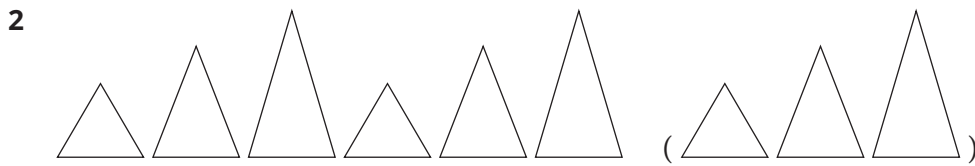
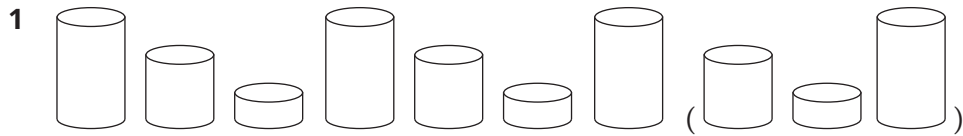

3 (the table must be shaded following the pattern.)

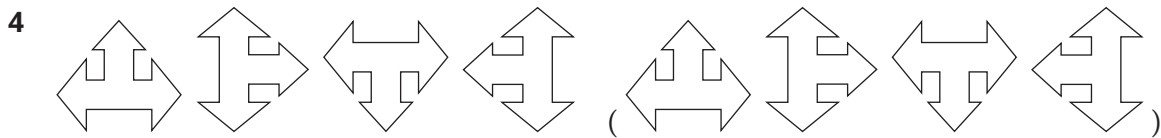
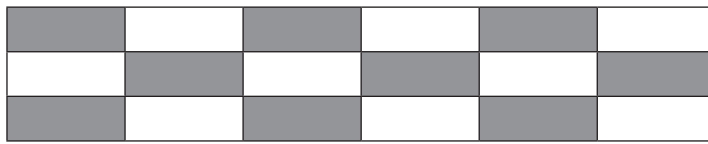

4 HOMEWORK ACTIVITY (5 MINUTES)

(Learner answers will vary.)

- 1 Find 3 different objects (2 of each) in your kitchen, like glasses, plates and bowls.
- 2 Use your objects to make a pattern.
- 3 Draw and extend your pattern in your book.

5 REFLECTION AND SUMMARY OF LESSON (5 MINUTES)

Call the whole class to attention and summarise the key concepts of the lesson.

Today we have learnt to describe, create and extend geometric patterns.

Lesson 45: Consolidation

Teacher's notes

This lesson allows for consolidation of the previous days' lesson content.

CAPS topics: 3.4 Symmetry, 2.1 Geometric patterns.

Lesson Objective: To revise symmetry and geometric patterns.

Lesson Vocabulary: : Forwards, backwards, symmetry, 2-D, geometrical, non-geometrical shapes, vertical line, horizontal line, diagonal line, predict, recognise, line of symmetry, symmetrical shape, whole, half, square, rectangle, geometric patterns, sequences, repeat, repetitive, copy, extend, describe, line(s), shape(s), object(s), circle, pattern

Resources: n/a.

Date:	Week	Day
-------	------	-----

1 NOTES FOR THE TEACHER RELATING TO THIS WEEK'S WORK

During this week, the learners have spent time exploring the concept of symmetry using different shapes. They were also introduced to geometric patterns. In this consolidation lesson we provide more work on both topics.

2 POSSIBLE MISCONCEPTIONS LINKED TO THE WEEK'S WORK

Learners may experience difficulties with symmetry and the idea that both halves should look the same. In order to assist learners you can use a mirror. Use the mirror to find the line of symmetry in simple shapes first, such as a heart. You can then move onto more difficult shapes such as the square.

3 CLASSWORK/HOMEWORK – COMPLETE THIS WEEK'S CLASSWORK AS NEEDED

Today we are going over what we learned this week. We are learning more about symmetry and geometric patterns.

4 ADDITIONAL ACTIVITIES FOR CONSOLIDATION – SEE LEARNER RESOURCES

1 Draw in lines of symmetry in the following shapes:

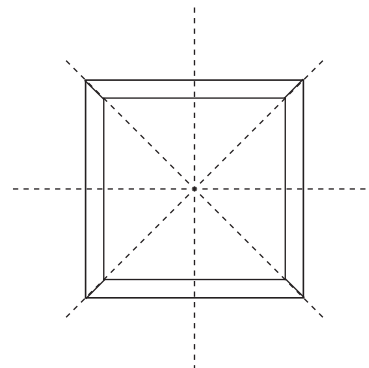
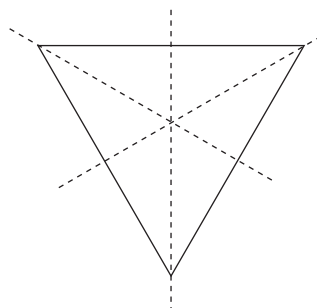
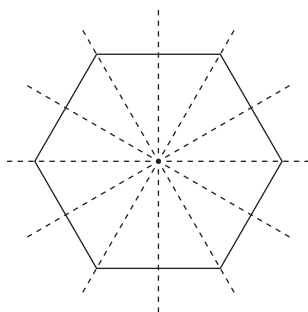

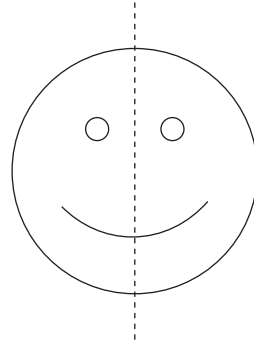
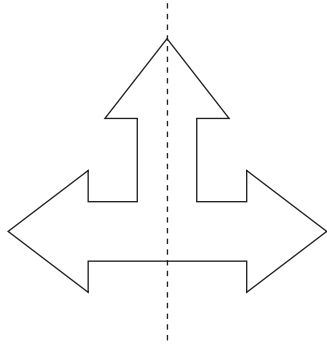

2 Copy and extend the following geometric patterns.

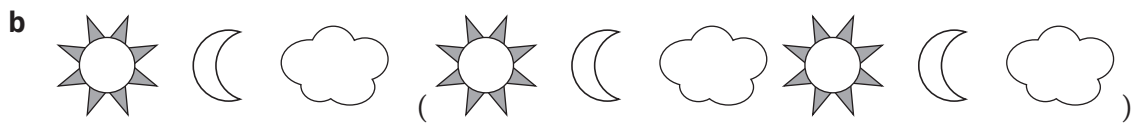
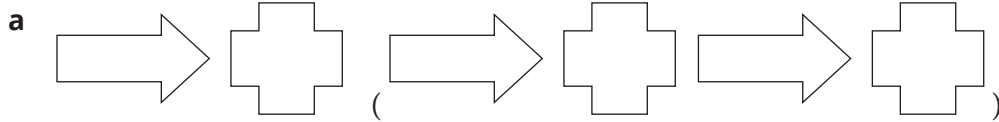

5 REFLECTION AND SUMMARY OF LESSON

Call the whole class to attention and summarise the key concepts of the lesson.

Today we have learnt about symmetry and geometric patterns.

Week 10

Lesson 46: Geometric patterns around us

Teacher's notes

This lesson is one of the fully planned lessons to be used to cover the Term 2 curriculum.

CAPS topics: 2.1 Geometric patterns.

Lesson Objective: To create and describe simple patterns where the number, size or position of shapes in each stage changes in a predictable way.

Lesson Vocabulary: Geometric pattern, physical objects, predictable, increasing, regular pattern, copy, extend, describe.

Resources: Plastic spoons, matchsticks, etc. (bring objects from home), learner's stationery or books (objects to use to make patterns).

Date:

Week

Day

1 MENTAL MATHS (10 MINUTES)

	What is the answer for....	Answer		What is the answer for....	Answer
1	$3 \times 10 =$	30	6	$2 \times 10 =$	20
2	$9 \times 10 =$	90	7	$10 \times 10 =$	100
3	$0 \times 10 =$	0	8	$5 \times 10 =$	50
4	$8 \times 10 =$	80	9	$7 \times 10 =$	70
5	$4 \times 10 =$	40	10	$6 \times 10 =$	60

2 LESSON CONTENT - CONCEPT DEVELOPMENT (45 MINUTES)

This is the second lesson on geometric patterns. In this lesson the learners will create patterns. These patterns will increase in a predictable pattern.

Today we are learning to create patterns made of shapes.

Activity 1: Learners work in groups

- Give each group some matchsticks.
- Ask them to use matchsticks to make a pattern with identical groups, where each group has only one kind of object but the position of the object in a group changes. Identical groups are repeated. E.g.

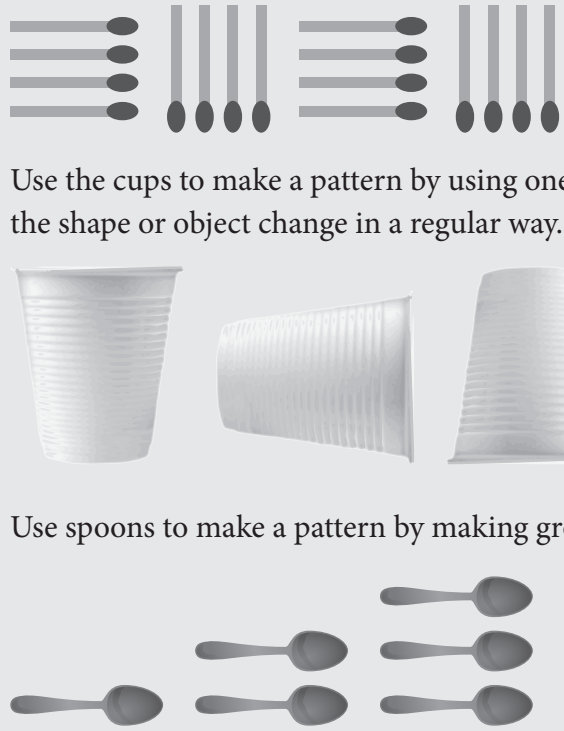

The image shows two examples of geometric patterns. The first example consists of four groups of objects: a group of four horizontal lines with circles at the right end, a group of four vertical lines with circles at the bottom, another group of four horizontal lines with circles at the right end, and a final group of four vertical lines with circles at the bottom. The second example shows three cups: a tall, straight-sided cup, a shorter cup that tapers from top to bottom, and a very short, wide cup that also tapers from top to bottom.

- Use the cups to make a pattern by using one shape or object, but having the position of the shape or object change in a regular way. E.g.
- Use spoons to make a pattern by making groups which grow in size. E.g.

Activity 2: Learners work in groups

In this activity learners should use their stationery to create patterns.

- Ask them to duplicate the patterns that they did in Activity 1 using their stationery. For example they can use pens/pencils to create patterns:
- Identical groups are repeated. E.g.



- Mixed groups are repeated. E.g.



- The positions of the items changes. E.g.



- The number of items changes. E.g.

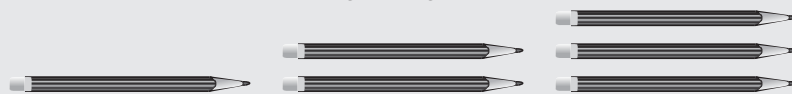

- Allow them to discuss the pattern in their groups.
- Each group gets a chance to show and describe their patterns in words to the rest of the class.
- Ask the learners to be **judges**. They are now going to choose the best pattern from all the groups. They also have to explain why they chose that specific pattern.

3 CLASSWORK ACTIVITY AND CORRECTION OF HOMEWORK (25 MINUTES)

(Answers will vary.)

- 1** Draw the pattern that your group made with the cups.
- 2** Describe the pattern.
- 3** Draw the pattern that your group made with the spoons.
- 4** Describe your pattern.
- 5** Design your own pattern, using triangles.
- 6** Describe the pattern.

4 HOMEWORK ACTIVITY (5 MINUTES)

Design a colourful and beautiful pattern.

- a** You may use any shapes and colours.
- b** Remember to extend the pattern you started with.
- c** You may use more than one pattern in your design.

5 REFLECTION AND SUMMARY OF LESSON (5 MINUTES)

Call the whole class to attention and summarise the key concepts of the lesson.

Today we have learnt to create patterns using shapes.

Lesson 47: Creating geometric patterns

Teacher's notes

This lesson is one of the fully planned lessons to be used to cover the Term 2 curriculum.

CAPS topics: 2.1 Geometric patterns.

Lesson Objective: To describe and create patterns where the size and shape changes in a predictable way.

Lesson Vocabulary: Geometric patterns, physical objects, increasing, decreasing, bigger, smaller, regular, extend, triangle, square, cube, forwards, backwards, calculate

Resources: Shape cut-outs (2) (see *Printable Resources*).

Date:

Week

Day

1 MENTAL MATHS (10 MINUTES)

	If I count in 100s, give me the number before:	Answer		If I count in 100s, give me the number before:	Answer
1	400	300	6	250	150
2	500	400	7	100	0
3	150	50	8	450	350
4	250	150	9	800	700
5	550	450	10	200	100



2 LESSON CONTENT - CONCEPT DEVELOPMENT (45 MINUTES)

This is the third lesson on geometric shapes. In this lesson the learners will create patterns. These patterns will change in terms of colour, shape and size.

Today we are learning to describe and create patterns that change in colour, shape and size.

Activity 1: Whole class activity

Draw the patterns on the board in preparation for this lesson.

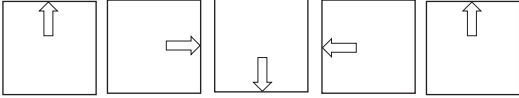
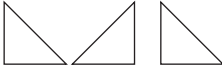
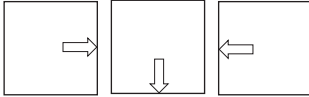
Type of pattern and example	Questions or instructions to learners
<p>Patterns with one shape/object, but the colours of the shape/object change in a regular way.</p> 	<p>Describe the pattern. (They are all triangles – black, grey, white, black, grey, white...)</p> <p>What will the next three shapes look like? (Black, grey, white triangles.)</p> <p>Draw them.</p>  <p>Make your own pattern with a different shape and your own colours.</p>
<p>Patterns where the position of the shape/object changes.</p> <p>Example 1:</p>  <p>Example 2:</p> 	<p>Describe the pattern.</p> <p>Example 1: (Triangles in pairs where the one is the symmetrical image of the other).</p> <p>The next three shapes will look like this:</p>  <p>Example 2: (A square with an arrow inside. The arrow points top, right, down, left, top).</p> <p>What will the next three shapes look like? Draw them.</p>  <p>Make your own pattern with a different shape and your own colours.</p>

Patterns with a single kind of shape, that increases or decreases in size.

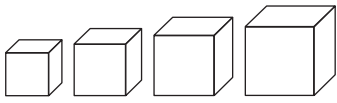

Describe the pattern.

(The pattern is made of cube blocks that get bigger and bigger.)

What will the next three shapes look like? Draw them.

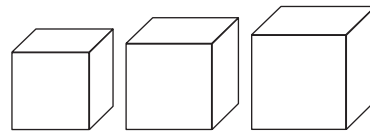

Make your own pattern with a different shape and your own colours.



Activity 2: Learners work in groups

Use the shape cut-outs.

- Learners should each make a pattern using some of the cut-out shapes on their desks.
- Groups discuss each of the patterns together – explain how the pattern grows.
- Some group members can present their pattern to the whole class (depending on how much time is available).

3 CLASSWORK ACTIVITY AND CORRECTION OF HOMEWORK (25 MINUTES)

NOTE: In this activity learners must also be able to explain the way in which their patterns grow. This is an important part of the activity as it gives learners the opportunity to develop their use of mathematical language.

- 1 Draw a geometric pattern and describe your pattern:
 - a Use triangles. (Answers will vary, e.g. )
 - b Use squares. (Answers will vary, e.g. )
 - c Use circles. (Answers will vary using circles of different sizes.)
- 2 Draw a geometric pattern using triangles, squares and circles.
- 3 Describe your pattern. (Answers will vary.)

4 HOMEWORK ACTIVITY (5 MINUTES)

- 1 Draw a geometric pattern and describe it.
 - a Use rectangles. (Answers will vary.)
 - b Use triangles and circles. (Answers will vary.)

5 REFLECTION AND SUMMARY OF LESSON (5 MINUTES)

Call the whole class to attention and summarise the key concepts of the lesson.

Today we have learnt to describe and create patterns that involve change in colour, shape and size.

Lesson 48: Exploring geometric patterns

Teacher's notes

This lesson is one of the fully planned lessons to be used to cover the Term 2 curriculum.

CAPS topics: 2.1 Geometric patterns.

Lesson Objective: To identify, describe, extend and develop geometric patterns.

Lesson Vocabulary: Forwards, backwards, geometric pattern, physical objects, predictable, increasing patterns, copy, extend, describe, size, shapes, predictable, regular pattern.

Resources: n/a.

Date: _____ Week _____ Day _____

1 MENTAL MATHS (10 MINUTES)

	If I count in 50s, give me the number before:	Answer		If I count in 50s, give me the number before:	Answer
1	400	350	6	250	200
2	50	0	7	100	50
3	150	100	8	450	400
4	250	200	9	500	450
5	550	500	10	200	150



2 LESSON CONTENT - CONCEPT DEVELOPMENT (45 MINUTES)

This is the last lesson on geometric patterns. In this lesson, the learners will identify, describe, extend and develop their own geometric patterns.

Today we are learning to extend and develop patterns.

Activity 1: Whole class activity.

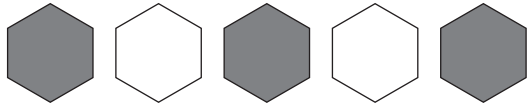
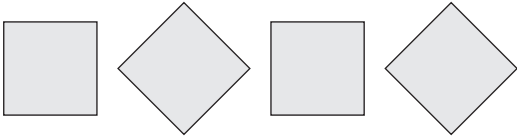
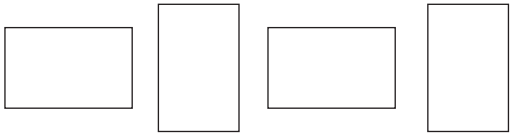
- Draw the patterns given in the table below on your board before the lesson starts. You will need to refer to these drawings when you explain the different kinds of patterns. You don't have to write the explanations – you will talk about these.
- Use the table below, which provides three different types of patterns, to teach learners how to
 - Identify
 - Describe
 - Extend and
 - Develop their own patterns.

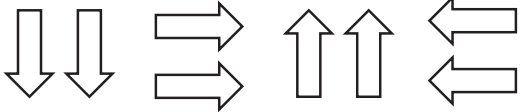
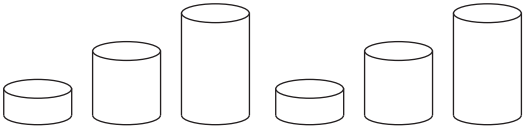
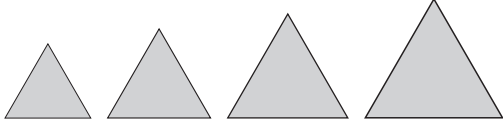
Type of pattern and examples	
<p>Patterns with one shape/object, but the colours of the shape or object changes in a regular way.</p> 	
<p>Patterns can be made by using one shape or object, but having the position of the shape or object change in a regular way.</p> 	
<p>Patterns with identical groups, where each group has only one kind of object but the position of the objects in the group change. Identical groups are repeated.</p> 	
<p>Patterns with a single kind of shape, that increases or decreases in size.</p> 	

Activity 2: Learners work in pairs

Instruct the learners:

- Make your own pattern with a different shape and your own colours.
- Describe the pattern. What will the next three shapes look like? Draw them.
- For example:

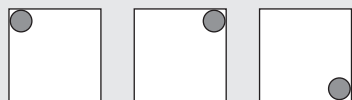

- **Describe the pattern.** (A square with a circle inside. The circle is at the top left, top right, bottom right.)
- **What will the next three shapes look like?** (The circle will be at the bottom left, then top left, then top right.)
- **Draw them.**

3 CLASSWORK ACTIVITY AND CORRECTION OF HOMEWORK (25 MINUTES)

1 Extend the patterns:

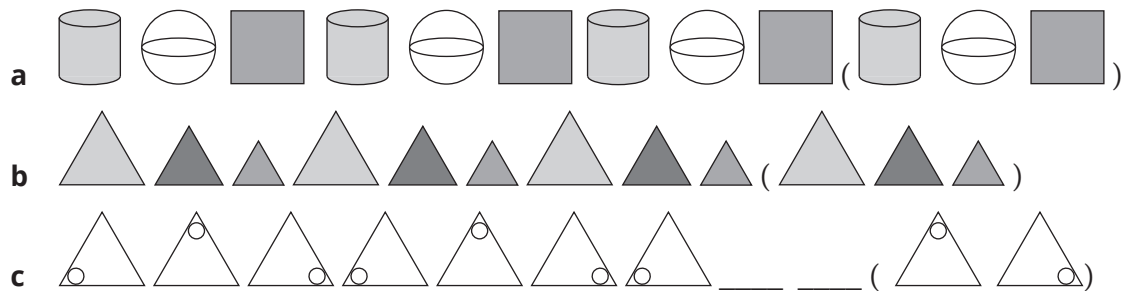

2 Use any of these shapes to make two different patterns. Describe your patterns.

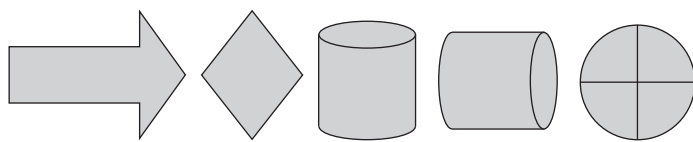

You don't have to use all the shapes in your two patterns.

Pattern 1:

(Answers will vary.)

Pattern 2:

(Answers will vary.)

4 HOMEWORK ACTIVITY (5 MINUTES)

- 1 Design and draw your own pattern using circles, squares and triangles. (Answers will vary.)
- 2 Describe the pattern. (Answers will vary.)

5 REFLECTION AND SUMMARY OF LESSON (5 MINUTES)

Call the whole class to attention and summarise the key concepts of the lesson.

Today we have learnt to extend and develop patterns.

Lesson 49: Assessment

Teacher's notes

This lesson should be used for assessment of the content covered in this unit to date.

CAPS topics: 2.1 Geometric patterns.

Resources: Printable assessment in teacher's resources.

Date:

Week

Day

1 SETTLE THE CLASS AND ADMINISTER THE ASSESSMENT. (45 MINUTES)

The assessment for today is linked to the work covered in the unit to date.

You will find the printable version of the assessment in the teacher's resource pack.

Take some time to do the *oral and practical assessment* (see rubric below).

2 DISCUSS ASSESSMENT ITEMS WITH THE CLASS (45 MINUTES)

Take in the learners' work when they are done.

There should be time for you to discuss a few of the items with the class:

- use this opportunity to reflect on different methods used by learners (allow some learners to write their solutions on the board).
- speak about misconceptions that may have arisen in learners' responses.

3 ASSESSMENT

WRITTEN ASSESSMENT (10 MARKS)

- 1 Draw the next shape in this pattern: (1)



( 1 mark for drawing the next shape in the pattern correctly)

- 2 Draw and extend a pattern in which the sizes of the shapes increase. (3)

Learners' answers will vary.

1 mark – pattern of shapes

1 mark – sizes of shapes increase

1 mark – at least one repetition of the pattern

- 3 Make your own pattern using circles and squares. (3)

1 mark correct shapes; 1 correct pattern (answers will vary)

- 4 Use three squares to draw a pattern. The size of the squares need to change in a regular way. Draw the pattern 2 times. (3)

(1 mark per correct answer) Any picture where squares were used, size changing in a regular way. (2)

ORAL AND PRACTICAL ASSESSMENT

Patterns and algebra: Geometric patterns		Mark: 7
Activity: Observe learners' ability to copy and extend geometric patterns.		
Mark	Criteria - rubric	
1	Unable to copy, extend or describe geometric patterns	
2	Able to copy geometric patterns	
3	Able to extend geometric patterns when assisted but makes many mistakes	
4	Able to extend geometric patterns when assisted but makes a few mistakes	
5	Able to extend geometric patterns without assistance but makes a few mistakes	
6	Able to extend geometric patterns without assistance correctly always	
7	Able to extend geometric patterns confidently and correctly	

Lesson 50: Consolidation

Teacher's notes

This lesson allows for consolidation of the previous days' lesson content.

CAPS topics: 2.1 Geometric patterns.

Lesson Objective: To revise and practise geometric patterns.

Lesson Vocabulary: Forwards, backwards, geometric pattern, physical objects, predictable, increasing patterns, copy, extend, describe, size, shapes, predictable, regular pattern.

Resources: n/a.

Date:

Week

Day

1 NOTES FOR THE TEACHER RELATING TO THIS WEEK'S WORK

This week we have continued to explore geometric patterns. The learners have identified, described, extended and developed their own geometric patterns.

2 POSSIBLE MISCONCEPTIONS LINKED TO THE WEEK'S WORK

Learners may struggle to describe a pattern. For example, they may say that the pattern is getting bigger with squares. It is important that the learners use the correct Maths vocabulary. For example, the pattern has increased in size/the position of the squares has changed. While you are teaching patterns, ensure that you use the correct vocabulary.

3 CLASSWORK/HOMEWORK – COMPLETE THIS WEEK'S CLASSWORK AS NEEDED

Today we are going over what we learned this week. We are learning more about geometric patterns.

4 ADDITIONAL ACTIVITIES FOR CONSOLIDATION – SEE LEARNER RESOURCES

1 Extend the following pattern:



2 Describe this pattern.



(The triangles decrease/get smaller.)

3 Create a pattern using circles that increase in size



- 4** Create a pattern with 3 squares. The squares should decrease in size.

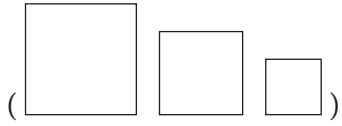

5 REFLECTION AND SUMMARY OF LESSON

Call the whole class to attention and summarise the key concepts of the lesson.

Today we have learnt about geometric patterns.